



Slope Reinforcement Design
Using Geotextiles and Geogrids

by ^{THESIS} 541861

Darrell M. Setser

A report submitted in partial fulfillment
of the requirements for the degree of

Master of Science in Engineering

University of Washington

1990

Program Authorized to Offer Degree _____

Date _____

T248076

Enclosure (1)

Thesis
541861
C.1

SLOPE REINFORCEMENT DESIGN
USING GEOTEXTILES AND GEOGRIDS

Introduction

The purpose of this paper is to present material properties and design approaches to consider when designing soil slopes reinforced with geosynthetics.

As the designer or a member of the construction team involved in a slope reinforced with a geosynthetic, one may have many questions regarding the use of geosynthetics as an engineering material. Some questions may include:

How do you approach the design of a geosynthetic reinforced slope?;

What is the standard of practice?;

What are the limitations?;

What type of soil should be used?;

What type of geosynthetic should be used?;

What tests are needed?

According to a recent article in "Geotechnical Fabrics Report", approximately 90 percent of the use of geosynthetics today is not by design but by past use on another project (Ausenus,1990). In order to obtain economical and safe use of geosynthetics in reinforced slopes, the slope should be designed in accordance with sound geotechnical engineering principles. Much research has been done on the use of geosynthetics in reinforced

slopes and the use of geosynthetics in this application continues to grow.

The historical development in civil engineering applications of geosynthetics, including reinforced slopes, can be reviewed in Koerner and Welsh (1980), Van Zanten (1986), and Koerner (1990).

The following definitions will be used in this paper. A geotextile is defined by American Society for Testing and Materials (ASTM) as:

any permeable textile material used with foundation, soil, rock, earth, or any other geotechnical engineering related material, as a integral part of a man-made project, structure, or system.

A geogrid is defined as:

any geotextile-related material used in a similar manner to geotextiles. They are usually made of plastic, but can be metal or wood (Holtz, 1988).

Geotextiles and geogrids will collectively be referred to as geosynthetics in this paper.

Geosynthetic reinforced slopes can be an economical alternative to conventional slope design. Soil reinforcement using high tensile strength inclusions can increase the shear resistance of a soil mass. This strengthening permits construction of soil structures at slope angles greater than the soil's angle of repose and/or

greater than would be possible without the reinforcement (Bonaparte et al., 1987).

The geosynthetics primary function in a slope design application is to provide reinforcement. A secondary function of drainage could also be realized depending on the particular design.

The main advantages of a reinforced slope structure are:

- a) Cost savings: when steeper slopes can be constructed using reinforcement, the quantity of fill material needed to build the slope structure is decreased (land acquisition costs may also be decreased);
- b) Increased stability: for a given geometry, the reinforced soil mass will usually result in an increased overall factor of safety;
- c) Possibility of constructing with poor soils: reinforcement may make it possible to construct slopes with materials which are not ideally suitable (Van Zanten, 1986);
- d) Increased ductility of the soil mass to resist dynamic loads.

Some specific applications may include:

- a) Reinforcing weak embankment soils;
- b) Widening existing embankments with limited right-of-way;
- c) Repairing landslides;

d) Raising existing dikes and levees.

Some specific military applications may include:

a) Equipment and personnel protective berms;

b) Bunkers.

Geosynthetics may be used at almost any slope angle and with almost any soil type as presented by Jewell (1985):

Type of <u>Reinforcement</u>	Slope <u>Geometry</u>	Fill <u>Soil Type</u>	<u>Bonding Mechanism</u>
Geogrid	30-90 deg.	Clay-Gravel	Bearing
Geotextile	45-90 deg.	Clay-Sandy gravel	Surface shear

Hermann and Burd (1988) suggest that the limit equilibrium design method they used may be conservative. Their work involved a steep reinforced soil embankment constructed of sand and a geogrid, built to act as a snow avalanche barrier in Norway. The slopes were 2v:1h with a wrapped facing, intermediate reinforcing layers and the primary reinforcement spanned the embankment width. The design was based on Jewell et al.(1984), assuming the pore pressure was equal to zero. The embankment was instrumented to measure strains, stresses and lateral displacements. The authors stated that, "the measured values of reinforcement strain were substantially less than those obtained from a detailed limit equilibrium analysis of the embankment in which the mobilized friction angle is based on pressure cell measurements of vertical and horizontal total stress." Haji Ali and Tee (1990) presented field behavior of two geogrid

reinforced slopes. One of their findings was that in one slope, the measured tensile forces at some locations (the lower levels) exceeded the design values, but at other locations the measured tensile forces were less than the design values. Tatsuoka et al.(1986) presented data which showed that steep slopes constructed with a sensitive clay and a nonwoven geotextile can be effectively stabilized.

A tremendous variety of geosynthetics are available. In reinforced slope applications, numerous design approaches exist. Designing slopes reinforced with geosynthetics requires an understanding of the material properties of the soil and the geosynthetic.

Material Properties in Design

Reinforcement of soil adds tensile strength to the previously unreinforced soil and by intuition an increase in the strength of the soil would be expected. The improvement in the strength of soils by reinforcement was evaluated in the laboratory in 1977 with triaxial tests (Broms,1977). The tests showed that the stress at failure of loose and dense sand is significantly increased with a geosynthetic reinforcement "properly" placed in the soil. In order to apply this laboratory work to practical problems in the field, certain material properties must be known.

Geotextiles and geogrids have been considered the same for reinforcing purposes and indeed they both provide a reinforced soil mass with tensile strength in the critical

direction. However, they differ in the manufacture process, various index properties and physical appearance. Either will provide reinforcement but geotextiles may provide drainage and separation as well.

The geosynthetics used in reinforcement of slopes are usually made of polyethylene, polyester or polypropylene. For information on the manufacture of these geosynthetics refer to Koerner (1990) and Van Zanten (1986).

In reinforcement applications, the primary material property of the geosynthetic needed is the tensile strength of the geosynthetic. Tensile strengths of geosynthetics may differ depending on direction. Other properties to consider may include:

- a) friction behavior;
- b) seam strength;
- c) creep;
- d) geosynthetic degradation.

The soil properties needed in the design of reinforced slopes are the same as those needed for a conventional slope design and can be obtained from the usual geotechnical procedures. In fact a conventional slope design, without reinforcement, should be evaluated first in order to determine the need for a reinforced slope.

In addition to the soil and geosynthetic properties, the interaction between the two is required to design a reinforced slope. The actual mechanics of the interaction

appear to be very complicated. Jewell (1985) states that the increase of the shear resistance (strength) of the reinforced soil is due to:

- a) bond stresses between the reinforcement material and the soil;
- b) reinforcement material properties;
- c) serviceability limits on allowable tensile strain in the reinforcement.

Jewell et al.(1984) provides a detailed description of the interaction between the soil and geogrids.

To determine the tensile strength to be used in design, the wide width tensile strength test (ASTM 4595) is the accepted standard for geotextiles. The tensile strength tests for geogrids are not standardized yet because of clamping difficulties of the geogrids. With either material the strengths most often quoted are unconfined strengths, and these are ordinarily used for design. When designing critical projects, confined tensile strengths may be needed. The confined tensile strengths may be much different than the unconfined strengths.

Even though a particular geosynthetic (a nonwoven, needle-punched, polypropylene) may be able to strain to a high degree (167%; Koerner,1990) before failure, this much movement in the slope is probably not desirable. For this reason 5-6% strain is accepted as the maximum elongation of the geosynthetic under working conditions (Van Zanten,1986).

With most compacted fills, the lateral strains developed in the soil during construction are 2-5%, which is another reason strains are limited in the geosynthetic. For long term satisfactory performance of the reinforced slope, the forces in the soil must be transferred to the reinforcement and vice versa. This compatibility is achieved by friction and passive resistance. Trying to ensure strain compatibility between the geosynthetic and the soil is also a design consideration, but it is usually only a guess since the interaction is a complex matter. The soil and reinforcement must work together to produce the strength needed.

Seam strengths are important only if a seam is parallel to the slope face. The current design practices only consider two dimensional problems, therefore deformations parallel to the slope face and seam strengths perpendicular to the slope face are neglected. If seams parallel to the slope face are allowed they will require critical inspection and testing to ensure proper strength. Consideration should be given to not permitting seams parallel to the slope face when preparing the specification. Various methods are used to make seams depending on the materials used in the slope. If the design involves going around corners, the reinforcement may have to be overlapped, cut, bent or folded.

Frictional properties for the interaction of the soil and the geosynthetic are needed for design and are usually obtained from a shear box test. The pullout resistance of the reinforcement, which is considered when trying to estimate the anchorage length of the reinforcement, can be modeled from a pullout test. It is important to use the same soil and geosynthetic in the above two tests as will be used in the actual construction.

Creep is important because the polymer geosynthetic materials exhibit visco-plastic behavior and may ultimately fail under a constant tensile force (Van Zanten, 1986). Degradation of the insitu geosynthetic reinforcement from temperature, chemicals, biological factors and sunlight need to also be considered in the design (Koerner, 1990).

One geogrid manufacturer utilizes a creep test lasting 410 days to define their long term design strength (Tensar, 1988). Higher temperatures (greater than 20 deg.C) will cause creep to be more of a problem and should be considered in the design.

During installation it is important to consider; puncture resistance, tear strength, stiffness (workability) and wear. These properties relate to how easily the geosynthetic can be damaged during installation and how easy (or difficult) the material may be to work with while being installed.

Design Approaches

In today's projects it is preferable to design by function and not by specification or cost; costs may be considered when more than one reinforcement will fulfill the functional requirement. Designers should also avoid writing the contract specification with a particular product in mind.

The steps for a reinforced slope design should include checks for internal (including slope face stability) and external stability. The slope stability design is usually accomplished by a conventional limit equilibrium analysis (Bishop, 1955) which has been modified to include the tensile force in the geosynthetic reinforcement. This method utilizes conventional Mohr-Coulomb strength criteria for the soil and the effect of the reinforcement in the soil mass. The reinforcement is usually added as a free body tensile force contributing to moment and force equilibrium.

Slope stability calculations today usually involve the use of a computer program to evaluate the many possible failure surfaces. These programs may be modified to allow for the resistance of the geosynthetic. When performing slope stability calculations either with a computer or by hand, it should be remembered that the critical failure surface located in the unreinforced soil mass may not be the critical failure surface of the reinforced soil mass (Berg et al., 1989). Most design procedures reviewed assumed the critical failure surface to be the same before and after the

reinforcement was added. Failure surfaces outside the reinforced soil mass should be checked to ensure external stability .

Traditional studies of slope stability are relevant to reinforced slope stability and include an understanding of:

- a) The precise behavior of materials involved and a quantification of the relevant properties (discussed in previous section and still developing);
- b) The mechanics of computing stability of earth masses for all types of failures (limited information and worthy of further study);
- c) A correlation between results of calculations and field observations;
- d) The geologic setting, rates of movement and causes of movement.

Conventional slope stability analysis assumes that:

- a) The failure occurs along a particular sliding surface and is two dimensional;
- b) The failure mass moves as a rigid body;
- c) The shearing resistance of the soil at various points along the failure surface is independent of the orientation of the surface;
- d) A factor of safety is defined in terms of shear stress applied and shear resistance available.

For the most part these assumptions are carried over into reinforced slope stability analysis.

In order to analyze a reinforced slope the requirements include:

- a) The desired slope geometry
- b) The forces the structure must resist to ensure stability including external and seismic loading;
- c) The pore water pressure or seepage conditions;
- d) The soil parameters and properties;
- e) The reinforcement parameters and properties;
- f) The interaction of the soil and the geosynthetic.

The design of a reinforced soil slope usually involves determining:

- a) The final geometry;
- b) The required number of reinforcement layers of a particular type;
- c) The vertical spacing of reinforcement layers;
- d) The embedment lengths of the reinforcement layers in order to prevent pullout and sliding;
- e) How to prevent the slope face from sloughing or eroding;
- f) Installation considerations.

Some other design considerations may include the availability of particular geosynthetics based on market and geographical considerations, costs (especially if the final design will be left to the contractor after the construction contract has been awarded), desires of the owner, aesthetics and the constructibility.

The various design procedures reviewed are listed below with more specific information on each contained in the appendix.

Slope Reinforcement Design Procedures Reviewed:

- a) Koerner, 1990;
- b) Van Zanten, 1986;
- c) Polyfelt Inc., 1989;
- d) Bonaparte et al., 1987;
- e) Verduin and Holtz, 1989;
- f) Ingold, 1982;
- g) Leshchinsky and Perry, 1987;
- h) Tensar Inc., 1988;
- i) Jewell et al., 1984.

All of the design procedures reviewed utilize a limit equilibrium analysis. Some are applicable to both cohesive and frictional soils while others are limited only to frictional soils. Four of the methods utilize a circular failure surface and four utilize a bi-linear failure surface with Leshchinsky and Perry (1987) utilizing a log spiral or a linear failure surface. The Polyfelt (1989) and Tensar (1988) methods are applicable to their respective geosynthetics only. The simplified method contained in Bonaparte et al. (1987) is the same method used by Tensar (1988). Many of the design methods contain design charts in order to simplify the design. Design examples from; Verduin and Holtz (1989), Leshchinsky and Perry (1987), and Ingold

(1982) are included in the appendix. The author recommends using the procedures proposed by Koerner (1990) and Verduin and Holtz (1989) for designing reinforced slopes. These procedures are easily understood and follow logically from conventional slope stability design methods.

For slope face problems, consideration should be given to:

- a) The use of intermediate reinforcement and surface matting through which vegetation can grow;
- b) wrapping the slope face with a geosynthetic;
- c) using masonry blocks, timber ties, precast panels, shotcrete, or grout filled fabric mattresses as facing (Bonaparte and Swan, 1990).

Factors influencing seismic slope stability design include:

- a) ground motions at the site;
- b) slope geometry;
- c) strength of the soil in the slope;
- d) strength of the reinforcement;
- e) strength of the soil/reinforcement interaction;
- f) acceptable amount of movements during design earthquake.

Information regarding the seismic design of slopes reinforced with geosynthetics is limited to the paper by Bonaparte, Schmertmann and Williams (1986). They used a

simple pseudo-static, rigid-body analytical model to compare the amount, length and distribution of reinforcement required to maintain slope equilibrium during seismic events. They presented the results of their investigation in a series of charts that compare the required reinforcing force and reinforcement length for seismic and static gravity loading conditions. For many practical applications, the results show that the number of layers of reinforcement required for the static loading condition provided sufficient reinforcing force to maintain equilibrium during seismic loading. However, the length of reinforcement will often need to be increased somewhat (approximately 10%, in the example by Bonaparte, Schmertmann and Williams, 1986) to maintain equilibrium during seismic loading. They considered materials to be well-compacted, dry to moist, frictional soil which is relatively free draining. It appears that more research is needed in this area including the seismic response of other soil types reinforced with geosynthetics and adapting conventional seismic slope stability analyses to reinforced slopes.

Costs

Once an acceptable design has been formulated, the costs to construct the reinforced slope may vary considerably depending on many factors, including:

- a) geographical area;
- b) complexity of the project;

c) method of contracting.

Some typical costs for geotextiles with a mass per unit area between 4.0-10.0 oz/yd² vary between \$0.60 to \$1.50/yd² for material and \$0.10 to \$0.50/yd² for installation depending on the site conditions, quantity and particular application (Koerner, 1990). Geogrids usually cost more than geotextiles when compared on a unit area basis.

Summary

Geosynthetic reinforcement of slopes is a relatively new option available to the civil engineer. Slope angles can be increased and "poor" soil can be utilized to construct economical soil-geosynthetic facilities. Uncertainties exist in the complex interaction between the soil and the geosynthetic but there are numerous procedures which ignore this in the design. The design procedures available may be conservative yet still may be an economical alternative when compared to more conventional options.

References

1. Ausenhus, Peter, "Special Report: Geosynthetics in the 1990's," Geotechnical Fabrics Report, March/April 1990, pp. 21-29.
2. Berg, R.R., Chouery-Curtis, V.E., and Watson, C.H., "Critical Failure Planes in Analysis of Reinforced Slopes," Proceedings, Geosynthetics '89, San Diego, IFAI, Feb. 1989, pp. 269-278.
3. Bishop, A.W., "The Use of the Slip Circle in the Stability Analysis of Slopes," Geotechnique, Vol. 5, 1955, pp. 7-17.
4. Bonaparte, R., Holtz, R.D., and Giroud, J.P., "Soil Reinforcement Design Using Geotextiles and Geogrids," Geotextile Testing and the Design Engineer, ASTM STP 952, J.E. Fluet, Jr., Ed., American Society for Testing and Materials, Philadelphia, 1987, pp. 69-116.
5. Bonaparte, R., Schmertmann, G.R., and Williams, N.D., "Seismic Design of Slopes Reinforced with Geogrids and Geotextiles", Proceedings, 3rd International Conference on Geotextiles, Vienna, IFAI, 1986, pp. 273-278.
6. Bonaparte, R., and Swan Jr., R.H., "Geosynthetic Reinforcement of Embankment Slopes," 1990 Chicago Geotechnical Lecture Series, Geosynthetics in Geotechnics, Chicago, 1990.
7. Broms, B.B., "Triaxial Tests with Fabric-Reinforced Soil," Proceedings, 1st International Conference on the Use of Fabrics in Geotechnics, Paris, 1977, Vol. 3, pp. 129-133.
8. Haji Ali, F., and Tee, H.E., "Reinforced Slopes: Field Behavior and Prediction," Proceedings, 4th International Conference on Geotextiles Geomembranes and Related Products, The Hague, Netherlands, May 1990, pp. 17-20.
9. Hermann, S., and Burd, H.J., "An Instrumented Steep Reinforced Soil Embankment at Andalsnes, Norway," Geotextiles and Geomembranes, Vol. 7, No. 4, 1988, pp. 293-308.

10. Holtz, Robert D., "Geosynthetics in Civil Engineering Construction," New Horizons in Construction Materials, Eds. D.Y. Lee and S. P. Shah, New York:ASCE, 1988.
11. Ingold, T.S., "An Analytical Study of Geotextile Reinforced Embankments," Proceedings, 2nd International Conference on Geotextiles, Las Vegas, IFAI, Aug. 1982, pp. 683-688.
12. Jewell, R.A., "Material Properties for the Design of Geotextile Reinforced Slopes," Geotextiles and Geomembranes, Vol. 2, No. 2, 1985, pp. 83-109.
13. Jewell, R.A., Paine, N., and Wood, R.I., " Design Methods for Steep Reinforced Embankments," Proceedings of the Polymer Grid Reinforcement Conference, London, 1984, pp. 70-81.
14. Koerner, Robert M., Designing with Geosynthetics, 2nd ed., Englewood Cliffs, N.J.: Prentice Hall, 1990.
15. Koerner, Robert M., and Joseph P. Welsh, Construction and Geotechnical Engineering Using Synthetic Fabrics, New York: Wiley, 1980.
16. Leshchinsky, D., and Perry, E.B., "A Design Procedure for Geotextile-Reinforced Walls," Proceedings, Geosynthetics '87, New Orleans, IFAI, Feb. 1987, pp. 95-107.
17. Polyfelt Inc., Design and Practice Manual, 2nd Printing, Evergreen, AL, June 1989.
18. Reinforcement of Earth Slopes and Embankments, NCHRP 290, Transportation Research Board, Washington, D.C., June 1987.
19. Tatsuoka, F., Ando, H., Iwasaki, K., and Nakamura, k., "Performances of Clay Test Embankments Reinforced With a Nonwoven Geotextile," Proceedings, 3rd International Conference on Geotextiles, Vienna, IFAI, 1986, pp. 355-360.
20. Tensar Corp., "Slope Reinforcement with Tensar Geogrids, Design and Construction Guideline," Tensar Technical Note TTN:SR1, Morrow, GA, Feb. 1988.
21. Van Zanten, R.Veldhuijzen, Ed., Geotextiles and Geomembranes in Civil Engineering, New York: Wiley, 1986.

22. Verduin, J.R., and Holtz, R.D., "Geosynthetically Reinforced Slopes: A New Procedure," Proceedings, Geosynthetics '89, San Diego, IFAI, Feb. 1989, pp. 279-290.

Appendix

An analysis was made of various design procedures with the following items noted:

1. Type of failure surface
2. Limit equilibrium analysis; yes or no
3. How reinforcement acts; horizontally or other
4. Design procedure applicable to:
 - a. Reinforcement type
 - b. Soil type
5. How factor of safety incorporated
6. Other

1. Circular
2. Yes
3. Horizontally
4. a. Geotextiles and geogrids
 - b. c, phi
5. Overall factor of safety greater than 1.3

Factored tensile strength used in equations as follows

$$\text{Allow. Prop.} = \text{Test Prop.} \cdot \left(\frac{1}{\text{FS}_{\text{ID}} \cdot \text{FS}_{\text{CR}} \cdot \text{FS}_{\text{CD}} \cdot \text{FS}_{\text{BD}}} \right)$$

Where:

Test Prop. = Ultimate Tensile Strength

FS_{ID} = The factor of safety for installation damage

FS_{CR} = The factor of safety for creep

FS_{CD} = The factor of safety for chemical degradation

FS_{BD} = The factor of safety for biological degradation

Typical values are recommended as follows:

	Geotextiles	Geogrids
FS _{ID}	1.1-1.5	1.1-1.4
FS _{CR}	1.5-2.0	2.0-3.5
FS _{CD}	1.0-1.5	1.0-1.4
FS _{BD}	1.0-1.3	1.0-1.3

6. Spacing and anchorage length considerations are addressed. Assumes no wrapping of geosynthetic at slope face.

From Koerner, 1990

The usual geotechnical engineering approach to slope stability problems is to use limit equilibrium concepts on an assumed circular arc failure plane, thereby arriving at an equation for the factor of safety. The resulting equations for total stresses and effective stresses, respectively, are given below corresponding to Figure 2.49. It is illustrated for the case of fabric reinforcement.

$$FS = \frac{\sum_{i=1}^n (N_i \tan \phi + c \Delta l_i) R + \sum_{i=1}^m T_i y_i}{\sum_{i=1}^n (w_i \sin \theta_i) R} \quad (2.45)$$

$$FS = \frac{\sum_{i=1}^n (\bar{N}_i \tan \bar{\phi} + \bar{c} \Delta l_i) R + \sum_{i=1}^m T_i y_i}{\sum_{i=1}^n (w_i \sin \theta_i) R} \quad (2.46)$$

where

FS = the factor of safety (should be greater than 1.3);

$N_i = w_i \cos \theta_i$;

w_i = the weight of slice;

θ_i = the angle of intersection of horizontal to tangent at center of slice;

Δl_i = the arc length of slice;

R = the radius of failure circle;

$\phi, \bar{\phi}$ = the total and effective angles of shearing resistance, respectively;

c, \bar{c} = the total and effective cohesion, respectively;

T_i = the allowable geotextile tensile strength;

y_i = the moment arm for geotextile (note that in large-deformation situations this moment arm could become equal to R , which is generally a larger value);

n = the number of slices;

m = the number of fabric layers;

$\bar{N}_i = N_i - u_i \Delta x_i$, in which

$u_i = h_i \gamma_w$ = the pore water pressure,

h_i = the height of water above base of circle,

Δx_i = the width of slice, and

γ_w = the unit of weight of water,

Use of the total stress analysis (Equation 2.45) is recommended for embankments where water is not involved or when the soil is at less than saturation conditions. The effective stress analysis equation (Equation 2.46) is for conditions where water and saturated soil

From Koerner, 1990

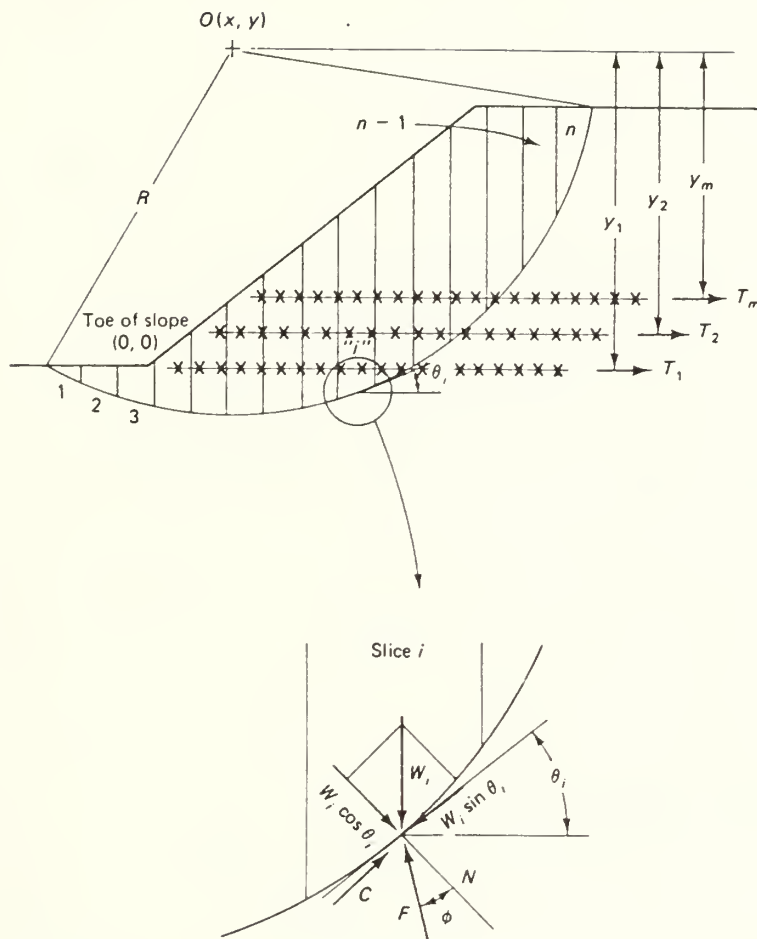

Figure 2.49 Details of circular arc slope stability analysis for (c, ϕ) shear strength soils.

are involved—conditions typical of earth dams and delta areas involving fine-grained cohesive soils.

These equations are tedious to solve, and when additional consideration is given to finding the minimum factor of safety by varying the radius and coordinates of the origin of the circle, the process becomes unbearable to do by hand. Many computer codes exist

that can readily be modified to include $\sum_{i=1}^m T_i y_i$ contribution of the geotextile reinforcement.

When the search is done independent of the computer, the analysis portion easily fits on most personal computers.

For fine-grained cohesive soils whose shear strength can be estimated by undrained conditions, the problem becomes much simpler. (Recall that this is the same assumption as was used in Section 2.6.1.3 on unpaved roads.) Here slices need not be taken, since the

From Koerner, 1990

soil strength does not depend on the normal force on the shear plane. Figure 2.50 gives details of this situation, which results in the following equation. The example illustrates its use.

$$FS = \frac{cR + \sum_{i=1}^m T_i y_i}{WX} \quad (2.47)$$

where

- FS = factor of safety (should be greater than 1.3),
- c = cohesion $0.5 q_u$ (where q_u = the undrained shear strength of soil),
- R = the radius of the failure circle,
- T_i = the allowable tensile strength of various geotextile layers,
- y_i = the moment arm for geotextile(s),
- W = the weight of failure zone, and
- X = the moment arm to center of gravity of failure zone.

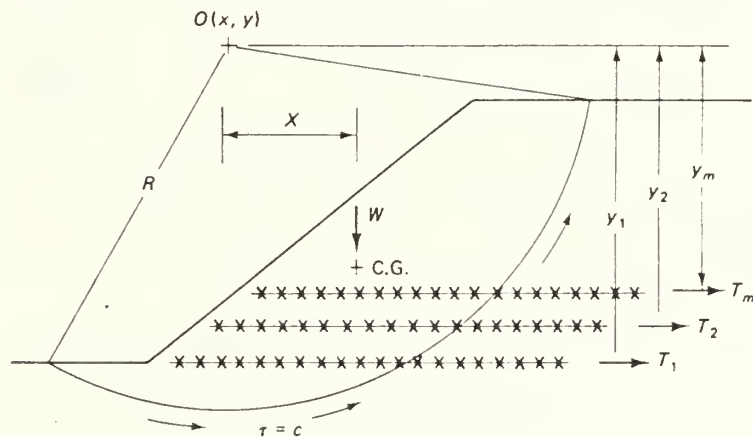

Figure 2.50 Details of circular arc slope stability analysis for soil strength represented by undrained conditions.

Example:

For the 21-ft.-high, 40 deg. angle slope shown below, which consists of a silty clay embankment ($\gamma = 120 \text{ lb./ft.}^3$, $\phi = 0 \text{ deg.}$, $c = 200 \text{ lb./ft.}^2$, area = 291 ft.^2 , center of gravity as indicated) on a silty clay foundation ($\gamma = 125 \text{ lb./ft.}^3$, $\phi = 0 \text{ deg.}$, $c = 300 \text{ lb./ft.}^2$, area = 250 ft.^2 , center of gravity as indicated) determine (a) the factor of safety with no geotextile reinforcement, (b) the factor of safety with a high-strength geotextile of allowable tensile strength 250 lb./in. placed along the surface between the foundation soil and the embankment soil, and (c) the factor of safety with five layers of the same geotextile placed at 5-ft. intervals from the interface to the top of the embankment. Assume that sufficient anchorage behind the slip circle shown is available to mobilize full geotextile strength and that seams are also adequate to transmit the stresses.

From Koerner, 1990

Solution: The following computational data are needed in all parts of the problem:

$$W_{abcd} = (291)(120) = 34,900 \text{ lb.}$$

$$W_{defg} = (250)(125) = 31,200 \text{ lb.}$$

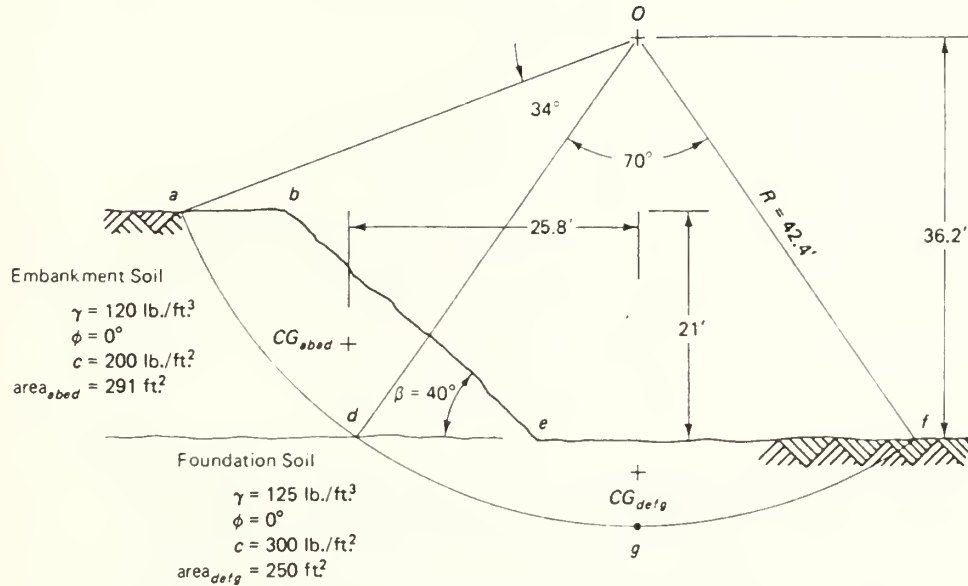

$$L_{ad} = 2(42.4)\pi \left(\frac{34}{360} \right) = 25.2 \text{ ft.}$$

$$L_{df} = 2(42.4)\pi \left(\frac{70}{360} \right) = 51.8 \text{ ft.}$$

$$FS = \frac{\sum \text{resisting moments}}{\sum \text{driving moments}}$$

(a) Slope as shown (with no geotextile reinforcement):

$$\begin{aligned} FS &= \frac{(c_e L_{ad} + f L_{df}) R}{W_{abcd} 25.8 + W_{defg} (0)} \\ &= \frac{[(200)(25.2) + (300)(51.8)]42.4}{34,900(25.8) + 0} \\ &= \frac{873,000}{900,000} = 0.97 \quad \text{NG; failure} \end{aligned}$$

(b) Slope with a geotextile along surface $e-d$ with sufficient anchorage beyond point d :

$$\begin{aligned} FS &= \frac{873,000 + 250(12)(36.2)}{900,000} \\ &= 1.09 \quad \text{NG; marginal situation} \end{aligned}$$

From Koerner, 1990

(c) Slope with five layers at 5-ft. intervals from surface *e-d* upward, all of which have sufficient anchorage behind the slip surface:

$$FS = \frac{873,000 + 250(12)(36.2 + 31.2 + 26.2 + 21.2 + 16.2)}{900,000}$$

$$= 1.41 \quad \text{OK; adequate safety}$$

Example:

For the preceding example, determine how much embedment (anchorage) is required behind the slip circle to mobilize the allowable tensile strength of the geotextile. Assume that the transfer efficiency of the fabric to the soil is 0.80 and base the calculation on a $FS = 1.5$.

Solution: When the anchorage test was explained in Section 2.2.3.11, it was assumed that the resistance was uniformly distributed over the fabric's embedment and that the fabric was entirely mobilized. This is almost certainly not the case. It appears that the concentration decreases rapidly as the embedment length increases and that separate mobilized and fixed portions of the fabric exist. For this problem, however, a linear distribution will be assumed over a continuous displaced length, since it results in a conservative length.

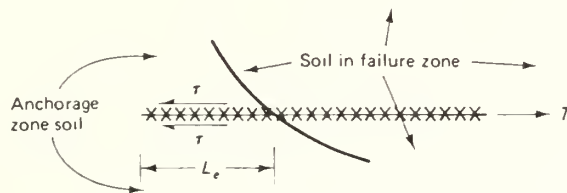

$$\Sigma F_x = 0; \quad 2\tau EL_e = T(FS)$$

$$2(200)(0.8)L_e = 250(12)(1.5)$$

$$L_e = 14.1 \text{ ft.}$$

use 15 ft. beyond slip circle for anchorage length of each fabric layer

1. Bi-linear wedge
2. Yes
3. Horizontally
4. a. Geotextiles only
b. c, ϕ
5. Factor of safety = 1.3
6. Spacing, anchor length and surface load considerations are addressed. Assumes wrapped slope face.

From Van Zanten, 1986

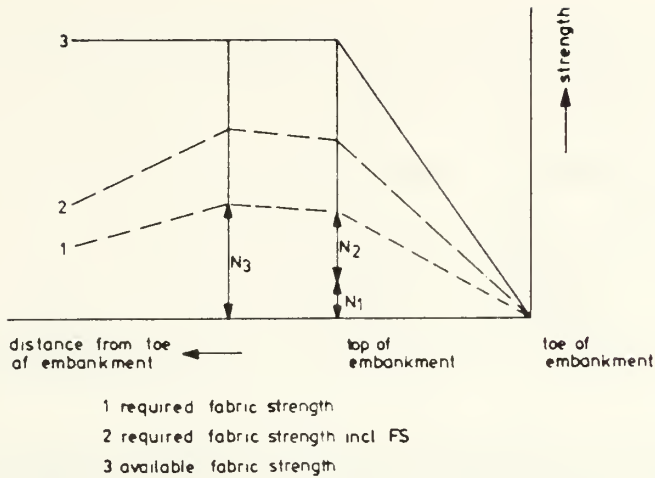

Figure 10.29. Summary of forces.

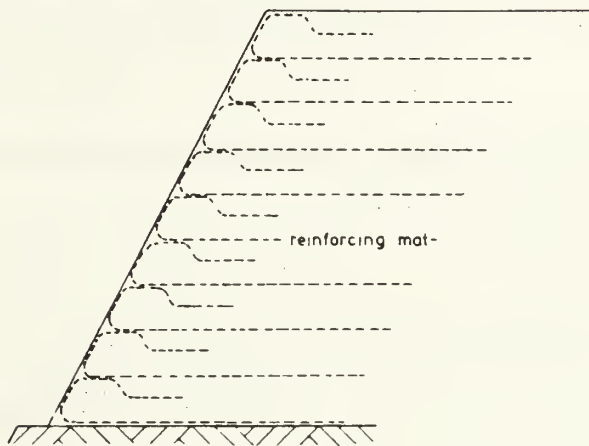

Figure 10.30. Cross-section of reinforced embankment.

The following aspects must be considered when calculating the stability of these constructions:

- reinforcement layer spacing,
- internal stability of the reinforced section,
- overall stability of the slope.

10.4.2.1 Reinforcement layer spacing

Broms (1980) developed the following method for calculating reinforced steep slopes. Figure 10.31 shows a cross-section of a retaining wall. The reduction of the horizontal or lateral earth pressure on the outside of such an embankment can be determined by considering the equilibrium of the forces exerted by two reinforcing mats.

The frictional resistance (τ), exerted by the reinforcing mat, will be proportional to the effective normal stress and, therefore, $\tau = \sigma'_v \tan \varphi_a$ (1), where φ_a is

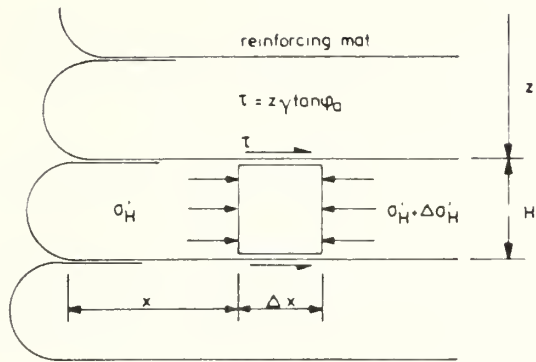

Figure 10.31. Equilibrium of forces near the outside of the embankment.

the angle of friction between the fill and the reinforcing mat, and σ'_v is the vertical soil pressure. For a reinforcing fabric, ϕ_0 corresponds to the angle of internal friction of non-cohesive or slightly cohesive soil. This frictional resistance (τ) increases the horizontal ground pressure on the soil cube, shown schematically in the sketch. At a distance X from the front face

$$2\tau dx = H d\sigma'_H \quad (10.17)$$

where

H = the distance between the layers of fabric.

Now

$$K_1 = \frac{\sigma'_H}{\sigma'_v} \quad (10.18)$$

where

K_1 = is a factor larger than the Rankine coefficient for the active earth pressure

$$K_a = (1 - \sin \phi) / (1 + \sin \phi).$$

σ'_v and σ'_H are no longer principal stresses owing to the mobilized frictional resistance τ . For non-cohesive material it can be shown that:

$$K_1 = \frac{1}{1 + 2(\tan^2 \phi)} \quad (10.19)$$

For sand, with $\phi = 35^\circ$, the value of K_1 , found from triaxial tests, is 0.5. This implies that the lateral earth pressure at a distance $X = H$ may already be 10 times larger than that calculated according to Rankine's active earth pressure theory. This also means that the effective lateral earth pressure at the front face of such a structure ($X = 0$) is very slight. Summarizing, both vertical and horizontal earth pressures increase rapidly away from the face.

The maximum spacing between two reinforcing mats is determined by considering:

- the distribution of the lateral earth pressure on the inside of folded-back envelopes,
- the effective load take-up by the reinforcing mat.

From Van Zanter, 1986

In this case it is assumed that the total lateral earth pressure is uniformly distributed over the vertical plane A-A (Figure 10.32), as suggested by Terzaghi-Peck (1967) for the dimensioning of anchored cofferdams, i.e.:

$$\sigma'_H = 0.65 K_a (1.5 q_s + \gamma H), \quad (10.20)$$

where

K_a = Rankine coefficient for active earth pressure

γ = bulk density of fill

H = height of earth-retaining structure [m]

q_s = static overburden pressure [kN/m^2]

0.65 = factor of safety introduced to cover the natural variations in lateral earth pressure and the variations of the unit weight and the angle of internal friction of the soil.

Note that the TRRL (1977) uses here $F_a = \gamma H K_a$. For design purposes, this is not so important where the extra Broms-FS is used at 0.65, since the final design is checked with the control calculation of Section 10.4.2.2.

From Equation (10.18) and Figure 10.32

$$H = \frac{N_{\max}}{0.65 K_a (1.5 q_s + \gamma \Sigma H)} \quad (10.21)$$

where

H = spacing between two reinforcing mats [m]

N_{\max} = allowable permanent load on the reinforcing mat [kN].

The required anchor length can be calculated using:

$$L = \frac{N_{\max} \text{FS}}{\gamma H \tan \varphi} \quad (10.22)$$

where

φ = φ_{soil} or φ_{fabric}

FS = factor of safety.

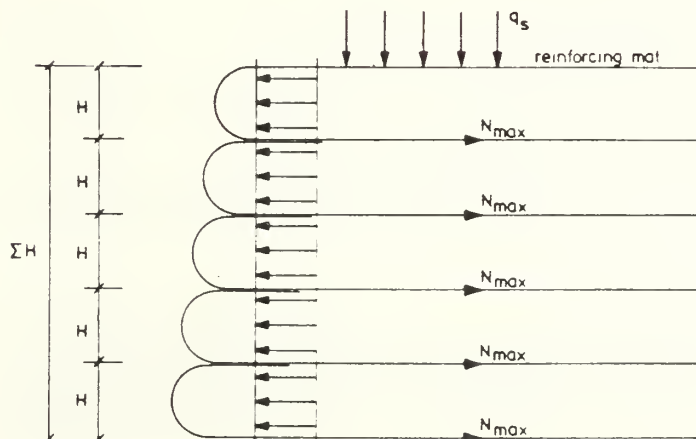

Figure 10.32. Anchor forces.

From Van Zanten, 1986

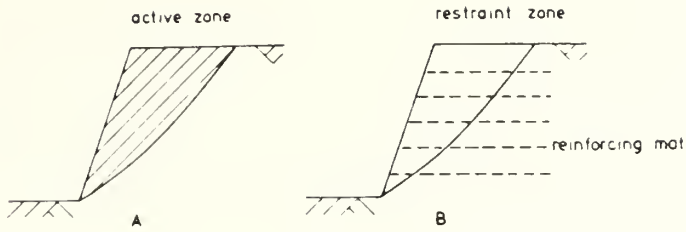

Figure 10.35. Method of anchoring the area which can slide to the stable part of the embankment.

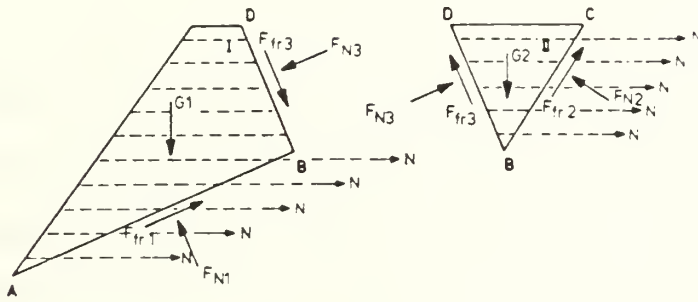

Figure 10.36. Equilibrium of the reinforced wedges.

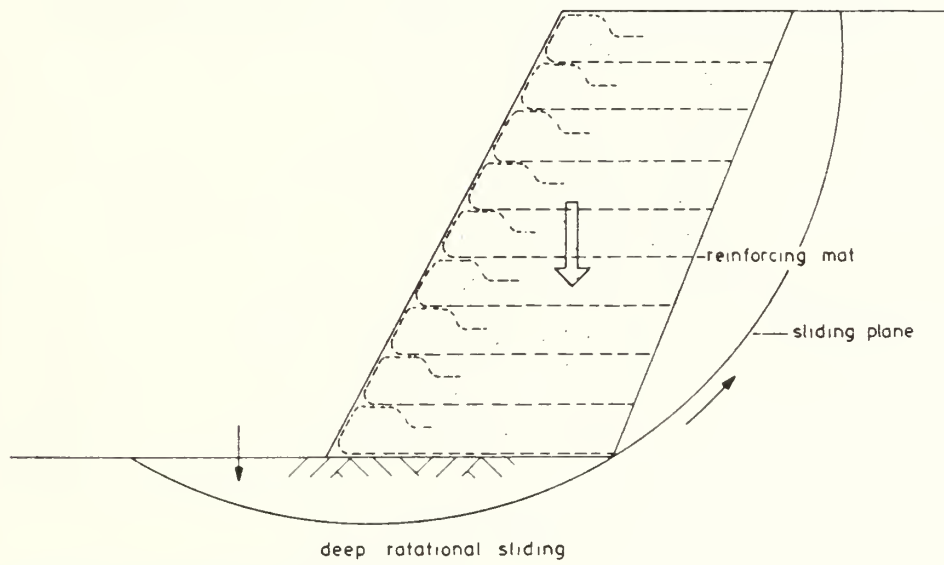

Figure 10.37. Overall stability of steep embankments.

10.4.2.3 Overall slope stability

The overall stability of the structure can be determined with the current methods for deep failure surfaces, e.g. Bishop, adapted for reinforcement layers intersecting the failure surface.

Polyfelt, 1989

1. Circular
2. Yes
3. Horizontally
4. a. Procedures applicable to Polyfelt brand geotextiles only.
b. c, phi
5. Factor of safety of 1.3 applied to c and phi and factor of safety of 3.0 applied to tensile strength.
6. Spacing, anchor length and geotextile strength recommendations addressed by charts. Assumes wrapped slope face. Various surface loading considerations given.

From Polyfelt, 1989

4.2 Internal Stability

The following computations for internal stability are based on Bishop's method of slices.

A factor of safety $FS = 1,3$ was selected for the soil parameters ϕ' and c' ; and for the geotextile tensile strength, the safety factor $FS = 3,0$ was chosen:

$$\tan \phi_o = \frac{\tan \phi'}{1.3} \quad c_o = \frac{c'}{1.3} \quad Z_o = \frac{Z_B}{3.0}$$

Where:

- c_o = Apparent soil cohesion (kPa)
- c' = Effective soil cohesion (kPa)
- ϕ_o = Apparent angle of internal friction ($^\circ$)
- ϕ' = Effective angle of internal friction ($^\circ$)
- Z_o = Apparent geotextile tensile strength (N)
- Z_B = Actual geotextile tensile strength (N)

The geotextile tensile strength Z_o was arranged as a horizontal force at the intersection of the geotextile plane and the sliding surface.

Thus, the stability F under load is, as follows; for the governing sliding surface, this value is stated as $F = 1$.

$$F = \frac{\sum_{k=1}^n \left[\frac{c_o + (p_k + T \cdot h_k) \cdot t_g \phi_o}{1 + t_g \phi_o \cdot t_g \alpha_k} \right] \cdot \frac{\Delta x_k}{\cos \alpha_k}}{\sum_{k=1}^n (p_k + T \cdot h_k) \cdot \Delta x_k \cdot \sin \alpha_k - Z_{o,k} \cdot \cos \alpha_k}$$

The individual parameters are as illustrated in Figure 13.2.

From Polyfelt, 1989

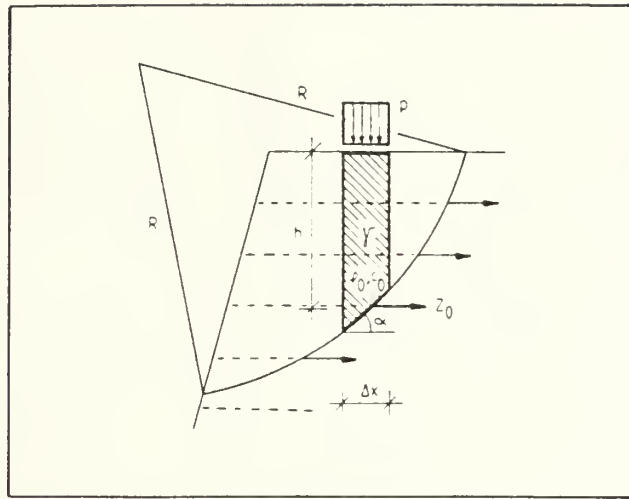

Figure 13.2: Parameters for the slice method of analysis

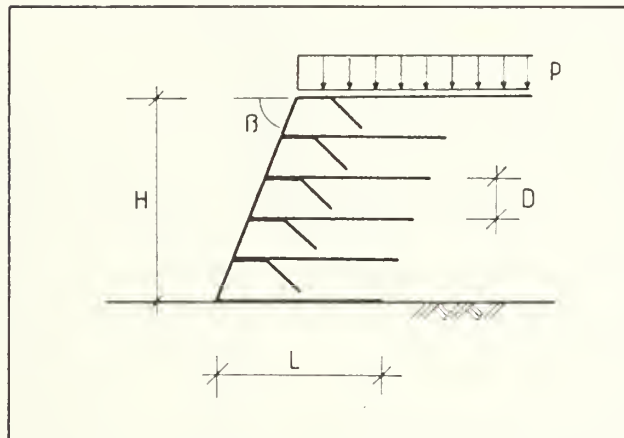
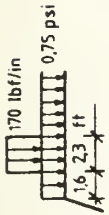
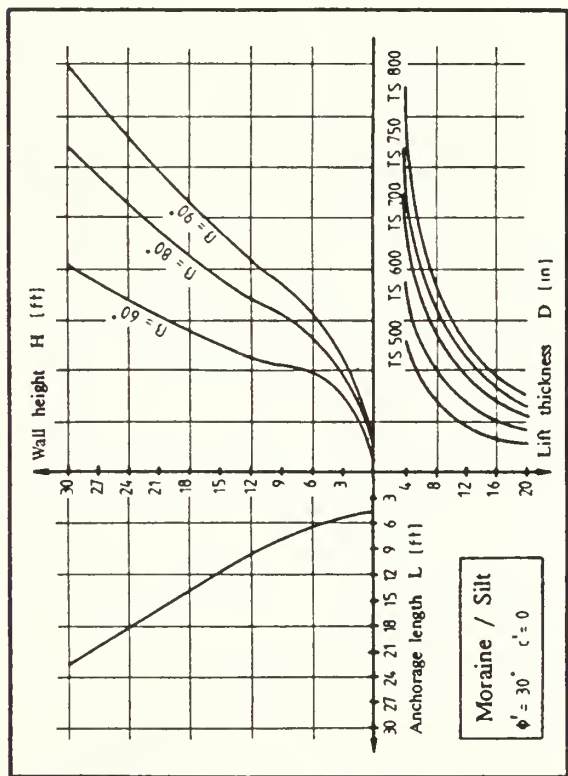
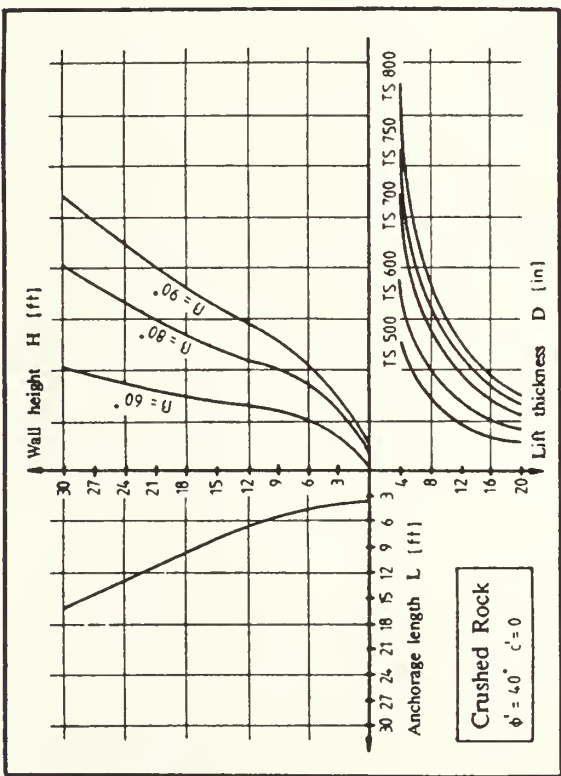
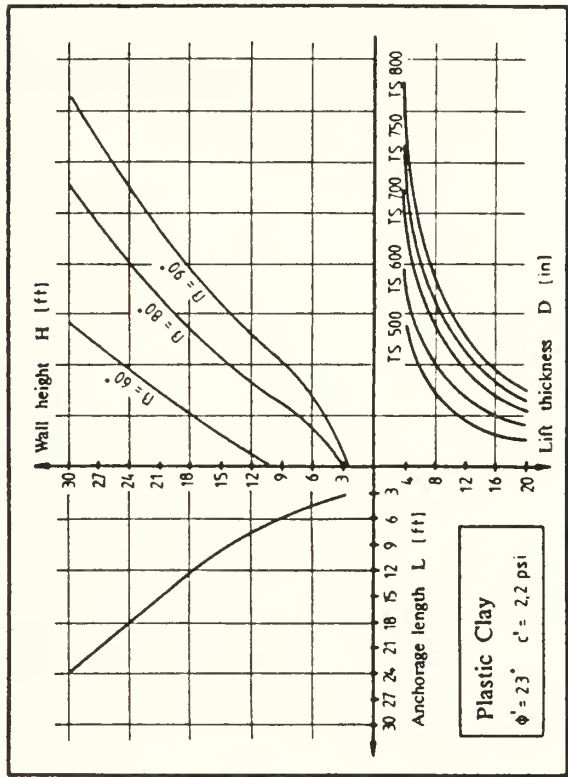
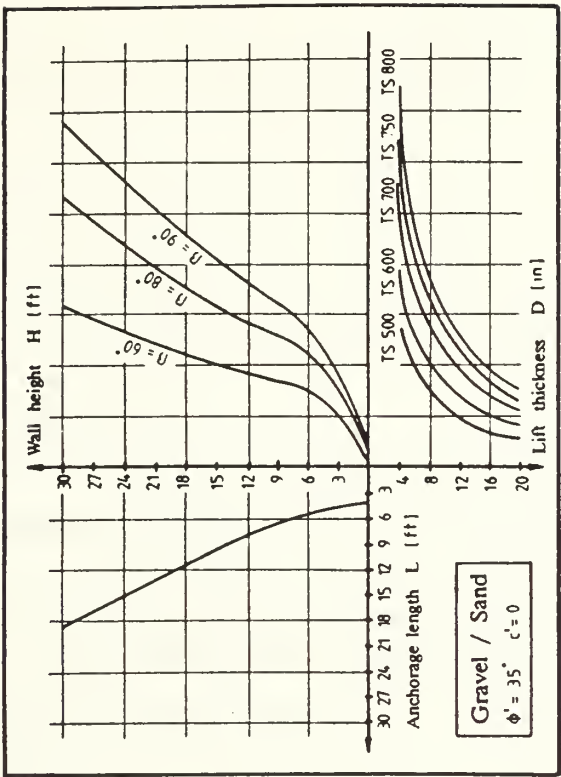

Figure 13.3: Elements of a geotextile reinforced retaining wall



Traffic 1



Diagrams 13.1/A through 13.1/D

1. Circular, except for infinite slope analysis near slope face
2. Yes
3. Horizontally
4. a. Author uses geotextiles only
b. ϕ only
5. Reinforcement tensile strength factored
6. Assumes wrapped face. Shows that tensile strains are not oriented horizontally when near the toe and face of the slope, but horizontal installation is the practical installation procedure.

From Ingold, 1982

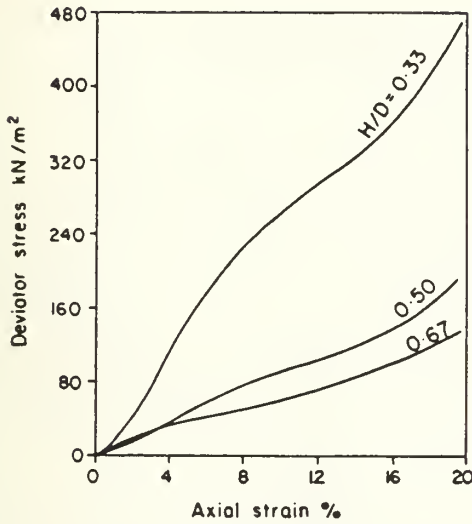

Fig. 6. Test Results for Encapsulated Sand

Using this encapsulating technique the soil close to the face of the latter is strengthened by the normal stress exerted by the reinforcement in contact with the latter face. The mechanism of the strength improvement close to the slope surface defies simple analysis, however, it will almost certainly involve the development of a stabilising stress analogous to an increase in minor principal stress the effects of which have been demonstrated, Ingold (20). It can be seen from Figure 5 for example that with a sufficiently rigid reinforcement with a vertical spacing S the increase in horizontal stress is approximately $\Delta\sigma_x = T/S$ where the reinforcement fails in tension and has an ultimate tensile strength of T kN/m. This possibility has been confirmed by triaxial compression tests carried out on samples of sand contained in cylindrical hags of knitted polyethylene. The hags which were 150mm in diameter, were filled with Boreham Pit sand, $d_{50} = 425\mu\text{m}$, $d_{60}/d_{10} = 2.8$, compacted to a dry density of 1.70Mg/m^3 . Three heights of sample, namely 50mm, 75mm and 100mm, were tested to explore the effects of reinforcement spacing. Compression tests were carried out unconfined. Test results, up to axial strains of 20%, are given in Figure 6 which indicates that deviator stress increases with decreasing sample height. In evaluating these results it should be remembered that since testing was carried out without the application of a cell pressure unreinforced samples would be associated with a near zero strength.

2 THE REQUIREMENTS OF A REINFORCING SYSTEM

One purpose of reinforcing an embankment is to enable the use of much steeper side slopes than those pertaining to unreinforced embankments whilst retaining the integrity of the reinforced mass. This entails designing against both superficial and more deep seated failures. Limiting considerations to a dry uniform cohesionless soil it can be shown that stability reaches a limiting condition as the slope angle approaches the internal angle of shearing resistance. For example infinite slope analysis indicates a factor of safety of unity when $\beta = \phi'$, thus if an unreinforced embankment could be constructed with $\beta > \phi'$ there would be failure. If it is assumed for the moment that the embankment is constructed on a competent foundation then failure would involve a series of slips on surfaces passing through the slope or toe of the embankment. As the slip debris is repeatedly removed there would be more slipping until ultimately a

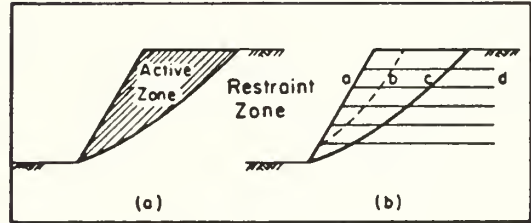

Fig. 7 Modes of Failure

stable condition is reached. This condition is illustrated in Figure 7a which shows the active zone where instability will occur and the restraint zone in which the soil will remain stable. The required function of any reinforcing system would be to maintain the integrity of the active zone and effectively anchor this to the restraint zone to maintain overall integrity of the embankment. In essence this requirement may be achieved by the introduction of a series of horizontal reinforcing or restraining members as indicated in Figure 7b. This arrangement of reinforcement is associated with three prime modes of failure, namely, tensile failure of the reinforcement, pull-out from the restraint zone or pull-out from the active zone. Using horizontal reinforcement that does not encapsulate the soil it would be difficult to guard against the latter mode of failure. Even ignoring the fact that the reinforcement may not be aligned in the appropriate tensile strain arc there is the problem of obtaining adequate bond lengths. This can be illustrated by reference to Figure 7h which shows a bond length ac for the entire active zone. This bond length may be adequate to generate the required restoring force for the active zone as a rigid mass, however, the active zone contains an infinity of prospective failure surfaces. Many of these may be close to the face of the latter as typified by the broken line in Figure 7h where the bond length would be reduced to length ah and as such be inadequate to restrain the more superficial slips. This reaffirms the soundness of using encapsulating reinforcement where a positive restraining effect can be administered at the very surface of the slope. This reiterates the necessity to develop analytical techniques to assess both superficial and more deep seated instability.

3 INFINITE SLOPE ANALYSIS

Infinite slope analysis may be applied to make some assessment of the possibility of minor slope instability. Reference to Figure 8 shows a typical reinforcement arrangement with horizontal encapsulating reinforcement set at a vertical spacing S . Consider first a planar

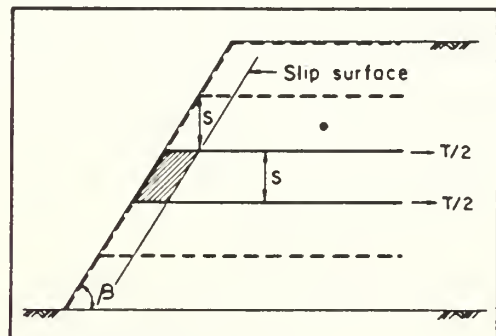

Fig. 8 Infinite Slope Analysis

From Ingold, 1982

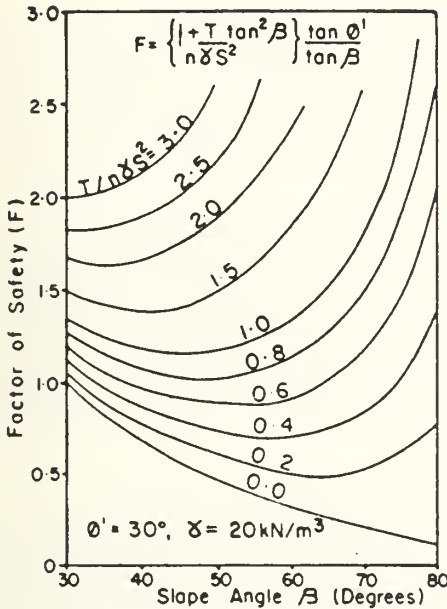

Fig. 9 Infinite Slope Analysis Results

slip surface parallel to the slope batter at a depth S below the slope surface of a dry cohesionless fill. Limiting consideration initially to the stability of the soil mass of weight W contained by two consecutive reinforcements and the slip surface, the hatched area in Figure 8, the disturbing force is $W \sin \beta$. For a soil of unit weight γ then $W = \gamma S^2 \cot \beta$. For deeper slip surfaces this weight would increase. Restricting the depths of slip surface investigated to multiples of the reinforcement spacing S then in general $W = n\gamma S^2 \cot \beta$ giving rise to a disturbing force $n\gamma S^2 \cos \beta$. Restoring forces will be generated by the soil, $n\gamma S^2 \cot \beta \cos \beta \tan \phi'$, and the reinforcement. The tensile force in the reinforcement may be resolved into the components parallel and normal to the slope. The former component is ignored since to be effective it must be transmitted through the unstable soil mass in the form of a shear stress. Assuming a tensile failure mode the normal component, $T \sin \beta$, would be mobilised provided the reinforcement is sufficiently stiff. In this case the restoring force is simply $T \sin \beta \tan \phi'$. Taking the factor of safety to be the ratio of restoring forces to disturbing forces, equation (2)

$$F = \frac{n\gamma S^2 \cot \beta \cos \beta \tan \phi' + T \sin \beta \tan \phi'}{n\gamma S^2 \cos \beta} \quad (2)$$

On rearrangement equation (2) reduces to equation (3)

$$F = \left\{ 1 + \frac{T}{n\gamma S^2} \cdot \tan^2 \beta \right\} \frac{\tan \phi'}{\tan \beta} \quad (3)$$

The expression in equation (3) has been evaluated for a range of slope angles and is given in the form of a design chart in Figure 9. As will be seen this, or similar charts, would not be used for the main design per se but merely to check that there is an adequate factor of safety against superficial instability.

4 CIRCULAR SLIP ANALYSIS

The circular slip analysis developed by Bishop (21) has

been chosen as the basis for reinforced fill embankment analysis. As a first stage the embankment is analysed unreinforced to define a range of critical factors of safety for various circle geometries. These factors of safety, denoted F_0 , are factored to permit determinations of ΔF which is the deficit between F_0 and the desired factor of safety F . Reference to the Bishop routine method summarised in equation (4) for a cohesionless soil shows that F_0 is a function of $1/m_\alpha$.

$$F_0 = \frac{\sum [W(1-r_u) \tan \phi' / m_\alpha]}{\sum W \sin \alpha} \quad (4)$$

where

$$1/m_\alpha = \sec \alpha / (1 + \tan \phi' \tan \alpha) / F_0$$

Thus to determine ΔF due allowance must be made for the fact that the final factor of safety operating in the soil will be F as opposed to F_0 . This has the effect of reducing the mobilised shear strength of the soil and so leads to a value of ΔF greater than $(F - F_0)$. It follows then from equation (4) that ΔF may be represented by equation (5) where m_α relates to the required factor of safety F and $m_{\alpha 0}$ relates to the factor of safety of the unreinforced embankment F_0 . In all cases the m_α values are the average values for a particular circle.

$$\Delta F = F - F_0 \frac{m_\alpha}{m_{\alpha 0}} \quad (5)$$

Having determined a value of ΔF for a particular slip circle the next step is to determine what reinforcement is necessary to fulfill this requirement. This might be assessed on a trial and error basis by assuming that the horizontal reinforcement generates a restoring moment ΔM which is the sum of the product of the individual tensile force developed in each reinforcing layer and its lever arm about the centre of the slip circle under consideration. That is $\Delta M = \sum TR \cos \alpha / F_R$, where F_R is the factor of safety against tensile failure of the reinforcement. The arrangement for a single layer of reinforcement is shown in Figure 10. Contrary to the assumptions of Binquet and Lee (22) the mobilised reinforcing force, T/F_R for each reinforcement, is assumed to act horizontally rather than tangentially. This assumption leads to a lower bound solution, however, this is not thought to be unduly conservative since for T/F_R to act tangentially would require significant movement along the slip surface and in fact for reinforcement stiff in bending the tangential condition may never be achieved. The effect of the reinforcement may be quantified by modifying the Bishop analysis as set out in equation (6)

$$F = \frac{\sum W(1-r_u) \tan \phi' / m_\alpha + \sum T \cos \alpha / F_R}{\sum W \sin \alpha} \quad (6)$$

In this analysis it is presupposed that the reinforcement fails in tension. This assumption does not lead to any complication since the length of each reinforcement embedded in the restraint zone can be adjusted to resist, with an appropriate factor of safety, any designed pull-

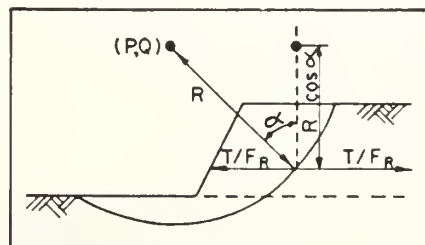

Fig. 10. Circular Slip Analysis

From Ingold, 1982

out force. The factor of safety against pull-out or tensile failure may be set at some arbitrary value. However, this does not mean that the maximum value of factor of safety of the reinforced fill embankment per se is limited to this same value. Obviously the greater the amount of reinforcement with a chosen local factor of safety, the greater the global factor of safety becomes.

5 THE DESIGN METHOD

The proposed design method is based on the philosophy presented in the preceding section, namely, to determine what reinforcement is required to obtain a specified factor of safety F for the reinforced fill embankment. Some indication of a simple approach was given by an initial series of dimensionless analyses which showed that, for a slip circle and slope of given geometry and soil properties, the restoring force, ΣT , for a given factor of safety varies in inverse proportion to the product γH^2 , equation (7)

$$\Sigma T / \gamma H^2 = \text{Constant} \quad (7)$$

Using this relationship an extensive dimensionless analysis was carried out for a series of embankment slopes reinforced with N layers of reinforcement of allowable tensile strength $T/F_R = H^2$ placed in the lower third of the embankment. Primary reinforcement was restricted to the lower reaches of the embankment since it is in this region that the reinforcement has the largest lever arm and is therefore the most efficient. The material of the embankment was assumed to have weight but no shear strength thus the resulting calculated factor of safety could be attributed to the reinforcement alone and is in fact the value ΔF cited earlier. By running a parallel series of analyses for unreinforced embankments of the same geometry but with fill material having finite strength it was possible to define pairs of values of ΔF and critical values of F_0 . These particular values of ΔF , for given values of D/H as defined in Figure 11 have been plotted in the normalised form of $\gamma \Delta F / N$ against slope angle β in Figure 11. The use of the design chart can be illustrated through the example shown in Figure 12. The embankment was first analysed unreinforced for a range of values of P, Q and D/H. This led to the minimum values of F_0 and consequently the ΔF values indicated in Table 1. In this particular case the value of ΔF has been calculated

assuming a required final factor of safety, F, of 2.

Table 1. Analytical Results

D/H	P	Q	F_0	ΔF	$\gamma \Delta F / N$	N	F
0	0	10.0	1.11	1.05	3.00	7.0	3.61
0.25	-2.5	12.5	1.00	1.07	1.72	12.4	2.42
0.50	-2.5	12.5	1.28	0.75	1.04	14.4	2.12

For the required value of $\beta=60^\circ$ Figure 11 is entered for D/H=0 whence a value of $\gamma \Delta F / N = 3.00$ is obtained. This is repeated for D/H=0.25 and 0.50 to render values of 1.72 and 1.04 respectively.

Knowing the required values of ΔF , the unit weight of soil, γ , and remembering that $T/F_R = H^2$, which in this case is 100kN/m, it is possible to evaluate N from the respective pairs of values of $\gamma \Delta F / N$ and ΔF . Table 1 shows for example that for D/H=0 it requires 7.0 layers of reinforcement with an allowable tensile force of 100kN/m to obtain the required factor of safety of two. Similarly 12.4 and 14.4 layers are required for D/H values of 0.25 and 0.50 respectively. Obviously the embankment must be reinforced for the worst case examined which occurs when D/H=0.50. It should be pointed out that in final selection of the primary reinforcement it is the product NT/F_R that must be adhered to. In this case 12 layers of reinforcement were adopted with an allowable tensile strength of $14.4 \times 100 / 12 = 120 \text{ kN/m}$. Since the primary reinforcement is to be restricted to the lower third of the embankment the required spacing is $10(3 \times 11) = 0.3 \text{ m}$. Using this reinforcement the embankment was re-analysed using an adapted Bishop routine method which incorporates the effects of the reinforcement. This resulted in values of final factor of safety F shown in the last column of Table 1. As would be expected the reinforcement requirement derived from the design chart renders high factors of safety for D/H values of zero and 0.25, however, for the most critical case occurring at D/H=0.50 the recalculated value of 2.12 is very close to the required value of two.

The above analysis has only considered primary reinforcement, namely that distributed in the lower third of the embankment and as such does not guard against more superficial failures that can occur in the upper two-thirds of the embankment. This can obviously be guarded against by the introduction of appropriate reinforcement. It is useful at this stage to invoke the relationship between tensile strength and the effective embankment height, H' , defined in equation (7). On this basis the reinforcement spacing may be maintained at 0.3m but the strength reduced. Bearing in mind that the above case need only be analysed for D/H' of zero the strength should be reduced from that determined for the original D/H value of zero, namely $(7 \times 100) / 12 = 58 \text{ kN/m}$. Thus the middle third of the embankment where $H' = 6.7 \text{ m}$ is reinforced at 0.3m c/c with reinforcement with an allowable

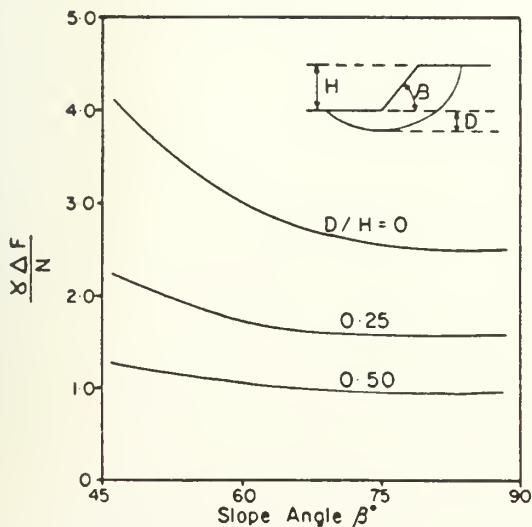

Fig. 11 Embankment Design Chart

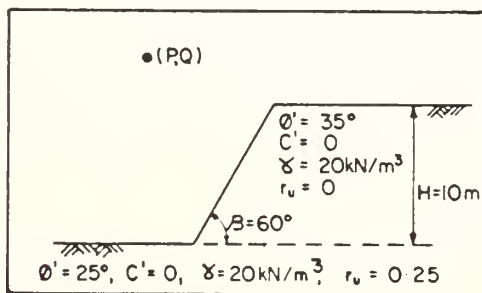
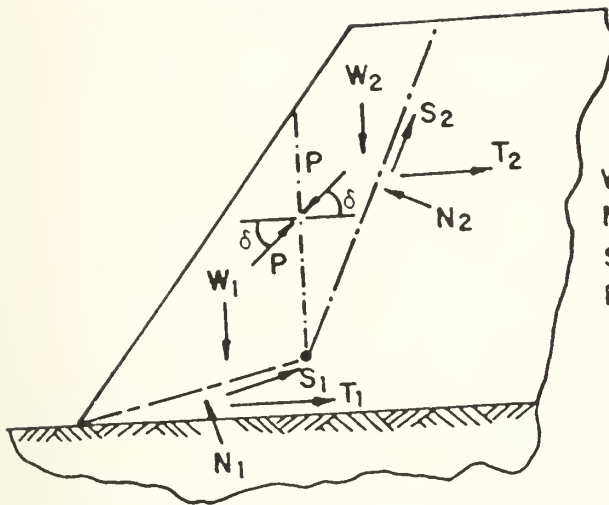

Fig. 12 Trial Analysis

Tensar, 1988

1. Bi-linear wedge and multi-part
2. Yes
3. Horizontally
4. a. Procedure applicable to Tensar brand geogrids only
b. ϕ only
5. Apply factor of safety to friction angle. Recommended allowable tensile strengths given.
6. Amount, spacing, anchor lengths and intermediate reinforcement considerations addressed.

From Tensar, 1988



W = Soil Weight
 N = Normal Force on Failure Plane
 S = Shear Resistance on Failure Plane
 P = Interslice Force
 δ = Angle of Interslice Friction
 T = Horizontal Geogrid Tensile Force

FIGURE 1
DIAGRAM OF TWO PART WEDGE ANALYSIS

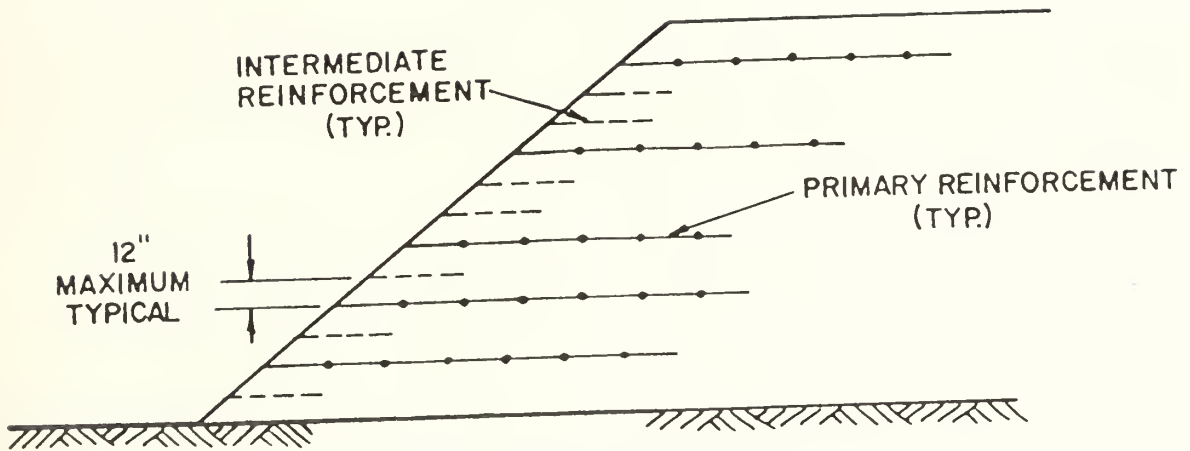

A. INTERMEDIATE REINFORCEMENT

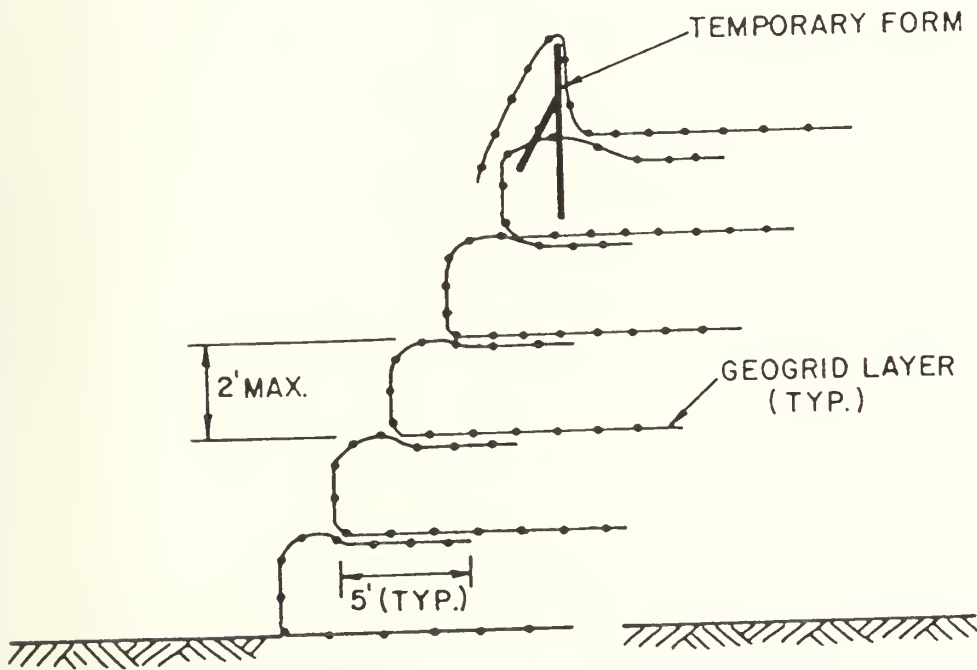

B. WRAP-AROUND CONSTRUCTION

FIGURE 9
CONSTRUCTION TECHNIQUES FOR
SLOPE FACE PROTECTION

1. Bi-linear wedge
2. Yes
3. Horizontally
4. a. Specifically developed for geogrids
b. phi only
5. Conventional overall factor of safety of 1.3 to 1.5.
Tensile reinforcement can also be factored.
6. Considers loads due to surcharges and pore pressures.
Probably can be applied to geotextiles.

$$\frac{c'}{\gamma H} = 0$$

$$\frac{E}{\gamma Z} = 0.50$$

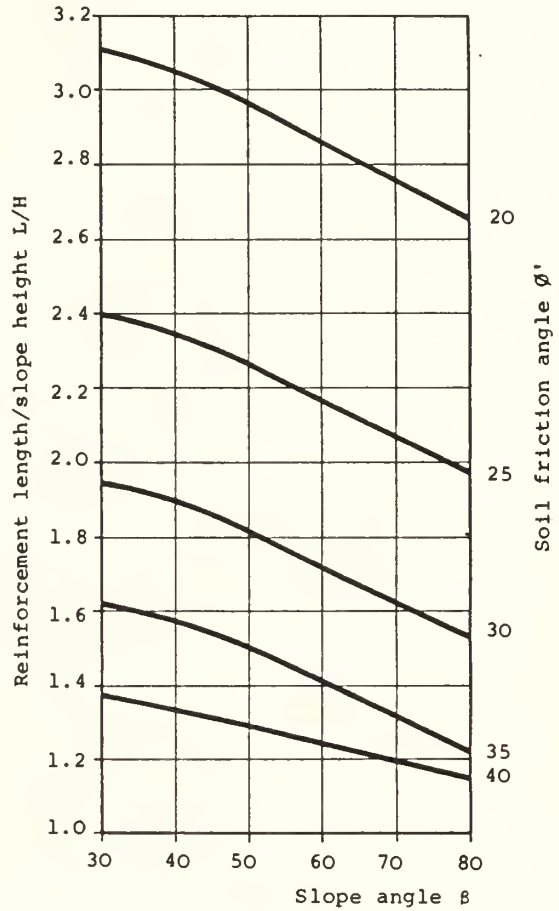
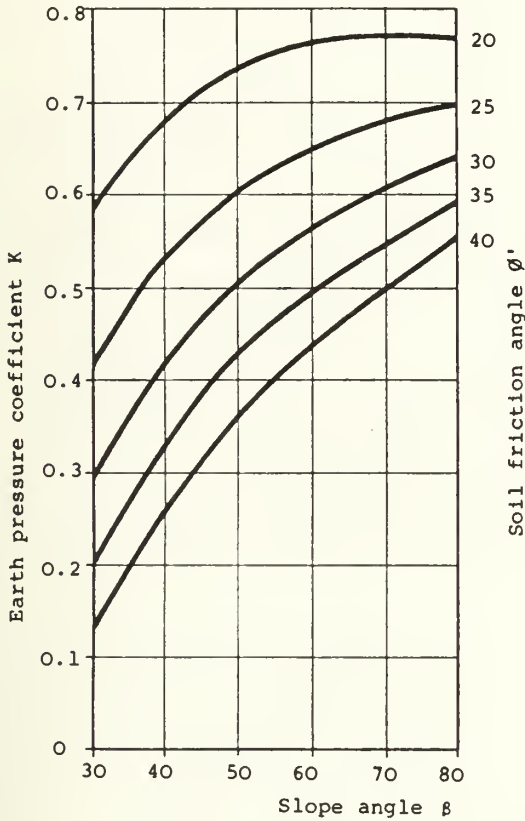
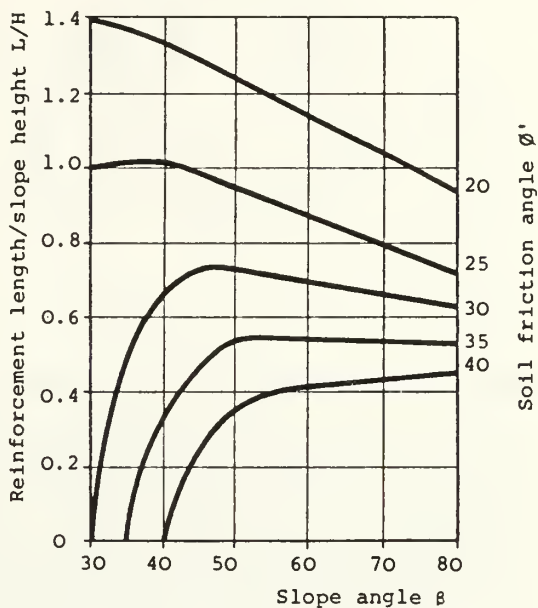
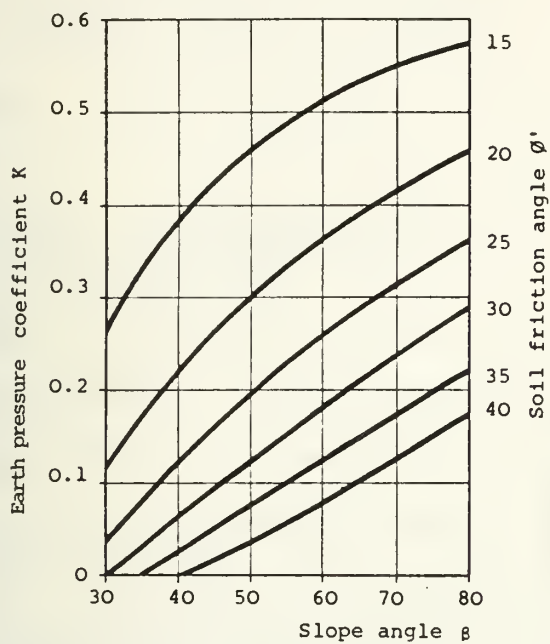

CHART DESIGN PROCEDURE

1. Select the required embankment dimensions and surcharge loading
2. Select design values of soil properties and pore water pressures
3. Determine earth pressure coefficient K and length of reinforcement L from the charts
4. Choose "in soil" design strength properties for the reinforcement and an overall factor of safety
5. Obtain the factored reinforcement force P
6. Choose a minimum vertical reinforcement spacing and the spacing constant $Q = P/K\gamma v$
7. Perform tabular calculation for the number and spacing of reinforcement layers
8. Calculate the total horizontal force required for equilibrium $T = \frac{1}{2}KH^2$
9. Check $T/(\text{number of layers}) \leq P$

$$\frac{c'}{\gamma H} = 0$$

$$\frac{u}{\gamma z} = 0$$



$$\frac{c'}{\gamma H} = 0$$

$$\frac{u}{\gamma z} = 0.25$$

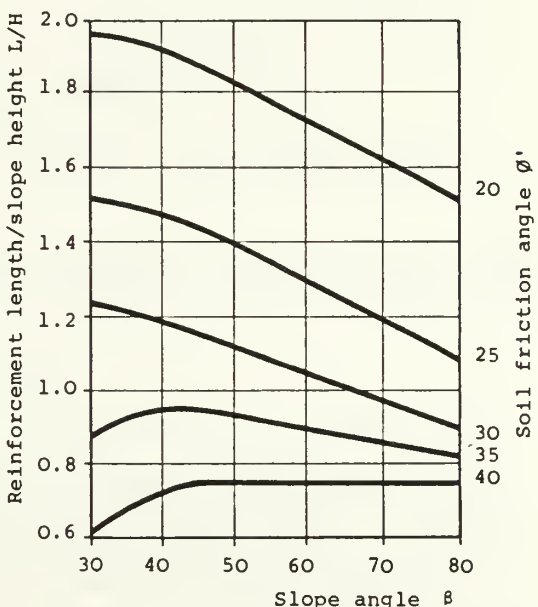
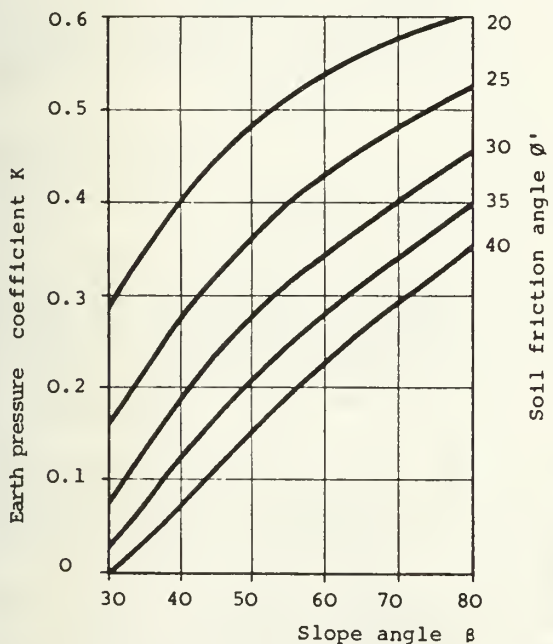

Interpretation of equilibrium compatibility between polymer reinforcement and soil in steep reinforced embankments is given in a final report, to provide a basis for selecting design values of parameters and safety margins.

cases examined

Charts have been devised for the following cases, Fig. 5

- Embankment slopes built over a competent level foundation that will not be overstressed by the constructed slope.
- Uniform slope with a horizontal crest.
- Uniform surcharge w_s along the slope crest.
- Slope angles β in the range 30° to 80° .
- Soils with effective stress strength parameters in the range $c' = 0$ and $\phi' = 20^\circ$ to 40° .
- Pore water pressures in the slope expressed by the coefficient r_u in the range 0 to 0.5 (See Bishop & Morgenstern (1960) and Fig. 5).
- Polymer reinforcement grids with constant length placed adjacently in horizontal layers. The design strength for the reinforcement grid allows for construction effects, environmental conditions in the soil and time effects on reinforcement mechanical behaviour during the design life of the structure.

steps for chart design

There are three main steps in the chart design procedure.

Firstly, the maximum horizontal force T required to hold the slope in equilibrium when soil and pore water pressures are at their design values is determined. If each reinforcement layer can support a maximum force P per unit width, then the minimum number of reinforcement layers N required for equilibrium is given by the ratio T/P .

Secondly, the minimum length L for the reinforcement layers is determined so that the reinforced zone is not overstressed by forces from the unreinforced interior of the slope, and to ensure adequate bond lengths.

Thirdly, as practical reinforcement layouts are likely to be divided into zones containing reinforcement at an equal vertical spacing, a relation is required to derive a practical reinforcement arrangement which will not lead to overstressing in any reinforcement layer.

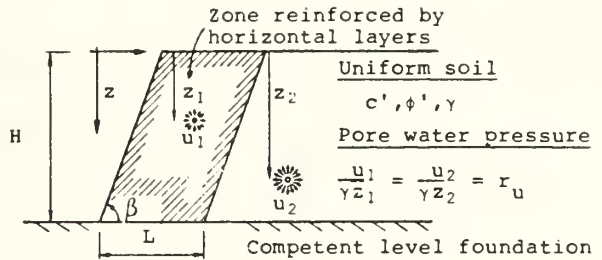

Fig.5. Definitions for the slope cases examined

GROSS HORIZONTAL FORCE REQUIRED FOR EQUILIBRIUM

The maximum horizontal force required to hold a slope in equilibrium has been estimated using the two-part wedge program WAGGLE. For a given slope, a search is made both for the worst wedge point location and the worst combination of wedge angles which give the greatest required force T , Fig. 6. This magnitude of force just provides equilibrium on the worst or critical two-part wedge when the design value of soil shear strength is fully mobilised.

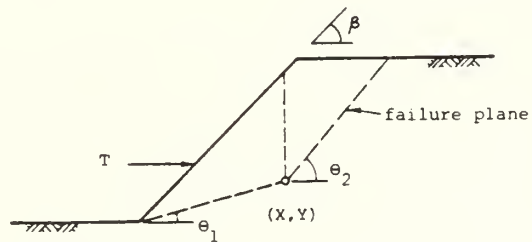

Fig 6. Definitions for two-part wedge mechanisms

The results of analyses are shown in Fig.7. The force T is plotted in a non-dimensional form against slope angle,

$$K = \frac{T}{\frac{1}{2} \gamma H^2} \tag{1}$$

where K is the coefficient of earth pressure.

Pore water pressures and effective soil cohesion both affect the magnitude of the gross horizontal force for equilibrium. A chart of the type shown in Fig. 7, applies for fixed values of the non-dimensional parameters for cohesion $c'/\gamma H$ and pore water pressure $u/\gamma z$.

The results shown in this case are for $\frac{c'}{\gamma H} = 0$ and $\frac{u}{\gamma z} = 0$.

1. Circular and bi-linear wedge
2. Yes
3. Horizontally and tangential
4. a. Geotextiles and geogrids
b. ϕ only when using simplified design charts from Schmertmann et al.
5. Factor of safety between 1.3 and 2.0 applied to c and ϕ . Allowable tensile resistance be limited to not more than 20 to 40% of peak tensile resistance taken from wide width test.
6. Amount, spacing and anchor length considered in simplified approach.

a.

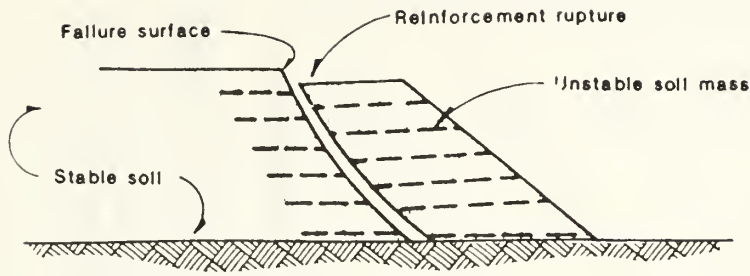

b.

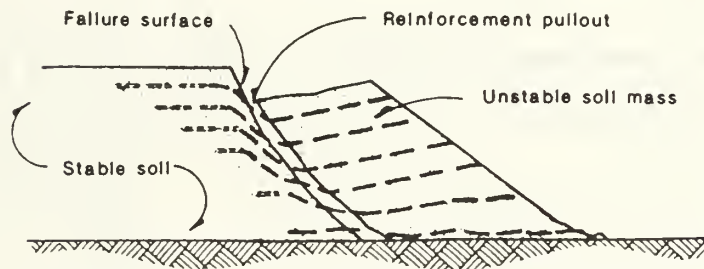
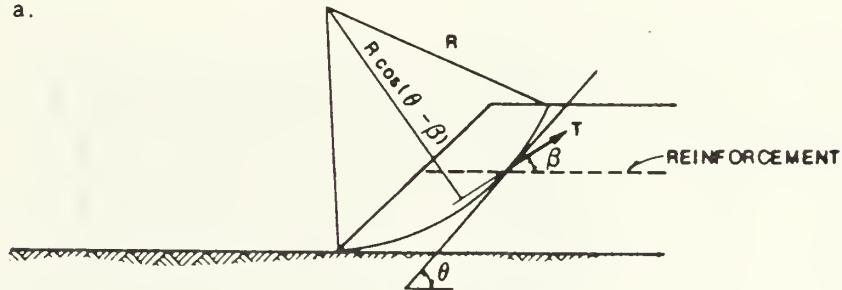

FIG. 15—Internal failure of reinforcement in slopes: (a) reinforcement rupture; and (b) reinforcement pullout.

a.



$$M_T = T \cdot [R \cos(\theta - \beta)]$$

$$0 \leq \beta \leq \theta$$

b.

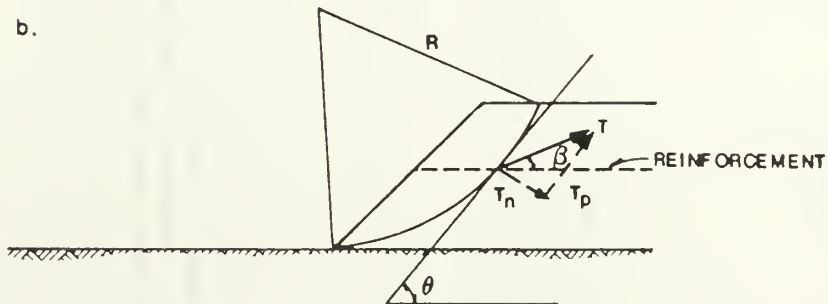

$$M_T' = T_p \cdot R + T_n \tan \beta' \cdot R$$

$$= RT [\cos(\theta - \beta) + \sin(\theta - \beta) \tan \beta']$$

$$= M_T [1 + \tan(\theta - \beta) \tan \beta']$$

FIG. 16—Stabilizing moment (M_T) due to reinforcement force: (a) reinforcement force assumed to act as an independent free-body force which does not effect soil strength; or (b) reinforcement force assumed to

1987

Reinforcement Orientation and Length—Ideally, reinforcement should be placed in the direction of maximum tensile strain. In slopes resting on competent foundations, the principal compressive strains are nearly vertical and the principal tensile strains are nearly horizontal [20]. Therefore, placement of the reinforcement in horizontal layers provides a high degree of reinforcement efficiency. Furthermore, the reinforcement is almost always placed horizontally because of the ease of construction.

Reinforcement should be long enough to encompass the entire unreinforced soil mass having potential failure surfaces with a factor of safety smaller than the specified design value. Using this approach, internal and external stability criteria are automatically satisfied. A final check should be made to verify that the reinforcement length is adequate to prevent reinforcement pullout.

Simplified Design of Reinforced Slopes

Simplified design charts have been developed for reinforced slopes [21-24] assuming a bilinear sliding wedge failure mechanism and a cohesionless slope fill. These charts can be used for the preliminary design of reinforced slopes. Schmertmann et al. [24] developed charts for determining the amount, length, and distribution of geogrid reinforcement required to maintain equilibrium in slopes constructed with cohesionless free-draining fills resting on competent, level foundations. The charts, which are extensions of earlier charts by Jewell et al. [22], were developed by evaluating the reinforcing force required to maintain horizontal equilibrium in the slope, as shown in Fig. 17. The angle of the resultant force between slices was assumed to be equal to the mobilized soil friction angle (which is assumed equal to the factored soil friction angle given by Eq 1: $\delta = \phi_1$). The reinforcement was assumed to act as shown in Fig. 16b and have a horizontal orientation at failure. The coefficient of friction for soil sliding over reinforcement was assumed to be 90% of the coefficient of friction for soil sliding over soil; this value is appropriate for granular soil sliding over geogrids, but it may not be appropriate for some geotextiles or for cohesive soils. The use of Schmertmann et al.'s charts are described in following paragraphs.

Amount of Reinforcement—The total horizontal tensile reinforcement force (T) per unit width of slope required to maintain equilibrium in a slope is calculated using Fig. 18. T is the sum of the required tensile forces at all reinforcement levels. The chart provides a force coefficient (K), derived from the results of the two-part wedge analyses (Fig. 17), which is used to calculate T (kN/m) as follows

$$T = 0.5K \gamma H^2 \tag{4}$$

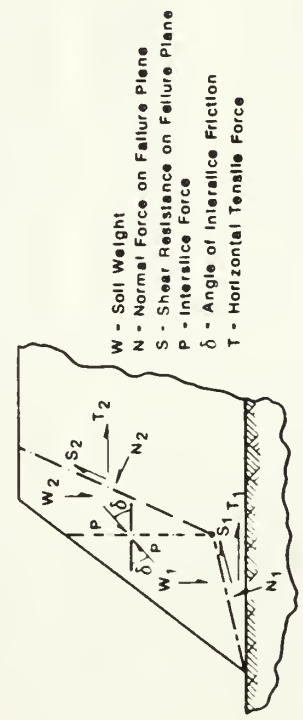

FIG. 17—Two-part wedge failure mechanism. (From Schmertmann et al. [24].)

where

- K = dimensionless coefficient given by Fig. 18.
- γ = unit weight of soil (kN/m³), and
- H = height of reinforced slope (m).

The input parameters to use with Fig. 18 are: β = slope angle; and ϕ_1 = factored soil angle of internal friction, obtained using Eq 1 so as to incorporate the design factor of safety. The required minimum number of layers of reinforcement, N , is determined by

$$N = T/\alpha_s \tag{5}$$

where

α_s = allowable tensile resistance provided by the reinforcement. Selection of the allowable reinforcement tensile resistance will be discussed subsequently.

The effect of a surcharge load, q (kN/m²), uniformly distributed on top of the slope, can be estimated by assuming that the surcharge loading is equivalent to an additional thickness of soil

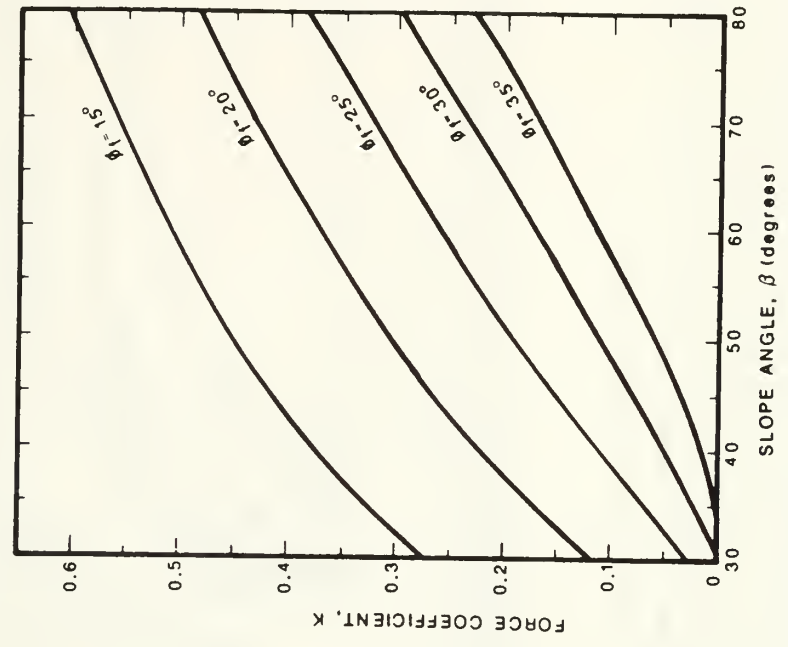

FIG. 18—Slope reinforcement design: chart for determination of the force coefficient, K , for the design of reinforced slopes constructed with granular-free draining fill. (Note: β = angle slope makes with horizontal; ϕ_1 = factored soil friction angle; from Schmertmann et al. [24].)

A30

placed on top of the slope. This equivalent thickness of soil results in an equivalent slope height, H' (m), given by

$$H' = H + q/\gamma \quad (6)$$

where

H = actual height of reinforced slope (m), and
 γ = unit weight of soil (kN/m³).

The equivalent slope height is used to calculate the total required horizontal tensile reinforcement force (Eq 4) as well as the reinforcement length. The use of the equivalent slope height concept is only applicable if the equivalent thickness caused by the surcharge (q/γ) is small compared to the actual slope height (H).

Distribution of Reinforcement—The next design step consists of distributing the N layers of reinforcement in a way that ensures stability of the reinforced slope at every level. (If all the required reinforcement was put at one level, Eqs 4 and 5 would be satisfied but the portions of slope above and below would be unstable.) The amount of reinforcement required at each level is proportional to the rate of change of total required tensile force with depth, $dT/dz = K\gamma z$, as shown by Jewell et al. [22]. The required amount of reinforcement therefore increases linearly with depth. Consequently, the maximum spacing S_v (m) between reinforcement layers will decrease inversely with depth, z (m), below the crest of the equivalent slope, according to:

$$S_v = \alpha_v/(K\gamma z) = H'^2/(2Nz) \quad (7)$$

where

K = dimensionless tensile force coefficient given by Fig. 18,
 γ = unit weight of soil (kN/m³),
 H' = equivalent height of slope (m), and
 N = minimum number of layers of reinforcement.

The selected spacing should, of course, be compatible with practical soil compaction lift thicknesses. Usually, to achieve a reinforcement layout compatible with compaction lift thicknesses, the final number of layers of reinforcement will exceed the minimum, N , by one or two.

If the number N is small, reinforcement layers may be far apart and there is a risk of slope failure between the reinforcement layers. From experience, a maximum spacing value of 1.0 m (3 ft) is recommended. If the number of layers, N , given by Eq 5 is such that spacing between reinforcement layers is larger than this recommended maximum, then either 1.0 m (3 ft) should be retained as the spacing or another type of reinforcement, with a smaller value of α_v , should be considered. The latter alternative is usually the more economical. A third alternative is to add a few intermediate layers of a weaker reinforcement material to improve stability between layers of main reinforcement.

Length of Reinforcement—The length of reinforcement is determined using Fig. 19. The chart shown in this figure was developed using the two-part wedge analysis indicated in Fig. 17 and is based on two criteria: (1) the reinforcement length must be sufficient to prevent reinforcement pullout; (2) the reinforcement length must be sufficient to prevent outward sliding along the interface of the soil and the bottommost reinforcement layer.

Figure 19 provides a minimum reinforcement length at the bottom of the slope, L_B (m), as well as at the top of the slope, L_T (m). In all cases, the minimum length of reinforcement at the bottom of the slope is larger than or equal to the minimum length at the top. A linear variation of reinforcement length between the top and bottom values is appropriate for reinforcement at intermediate elevations.

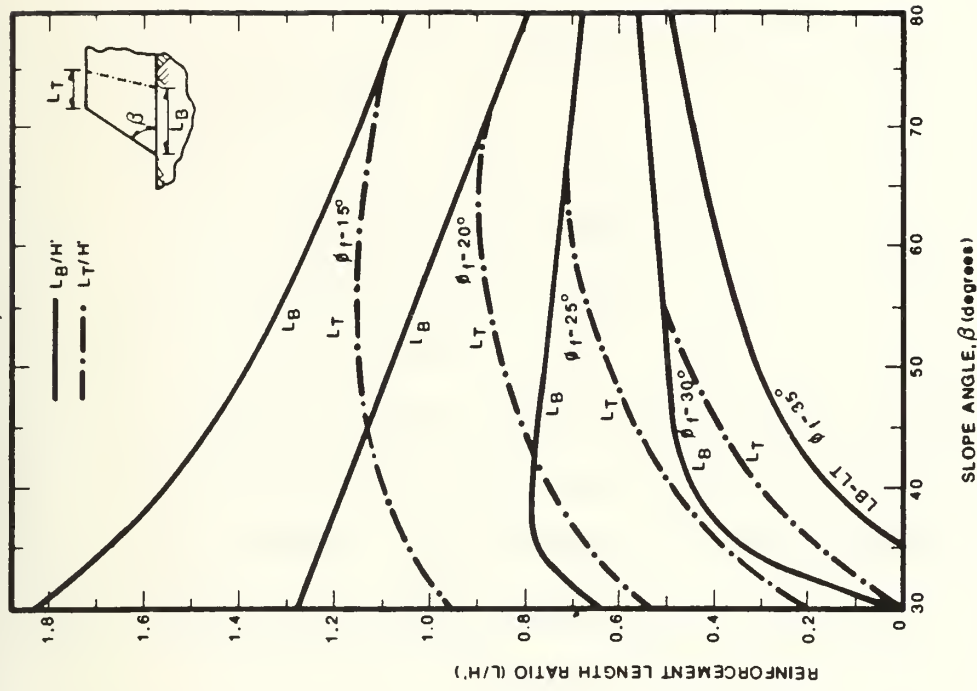

FIG. 19—Slope reinforcement design: chart for the determination of reinforcement length, L , for slopes constructed with granular-free draining fill. (This chart is for a soil-reinforcement interface shear strength equal to 90% of the soil shear strength.) (Note: ϕ_f = factored soil friction angle. H' is given by Eq 6; from Schmertmann et al. [24].)

Reinforcement Properties and Relevant Test Methods

Limit Equilibrium Design—Ideally, the allowable reinforcement tensile resistance for design of reinforced slopes should be based on long-duration confined creep tests. Unfortunately, data from this type of test are virtually nonexistent. In fact, unconfined creep test results are available for only a few commercially available geotextile and geogrid products. For critical applications, allowable tensile resistances should be based on creep tests and specifying engineers should require certifiable creep test data from the material manufacturer as a prequalification for the specification of a material for a critical structure. For less critical applications, a simpler approach is justified: allowable tensile resistances can be based on the ASTM wide strip test

1. Circular
2. Yes
3. Horizontally or tangential
4. a. Geotextile or geogrid
b. c and ϕ
5. Overall factor of safety applied to moment equilibrium and factor of safety applied to anchorage required.
6. Considers pore pressures and surcharges. Provides for various strengths, spacing and lengths.

J.R. VERDUIN

Hart-Crowser, Inc., U.S.A.

R.D. HOLTZ

University of Washington, U.S.A.

Geosynthetically Reinforced Slopes: A New Procedure

SUMMARY

The paper presents a simple but practical method for the design of slope reinforcement with geosynthetics. A circular failure surface is assumed, and surcharges and pore pressures can be taken into account. Any convenient method of analysis of the unreinforced slope can be used as long as the coordinates of the slip circle and the safety factor of the unreinforced mass are known. Conventional construction practices including site location, foundation stability, geosynthetic spacing, and project budget can be appropriately considered. Three reinforcement conditions are possible: 1) equal number and strengths of reinforcement layers in the top and bottom portions of the slope; 2) different number and strengths of reinforcement in the top and bottom of the slope, and 3) an equal number but different strength reinforcement layers in the top and bottom of the slope. Design for both sliding and pullout are considered. The design procedure can easily be programmed. An example problem is presented.

INTRODUCTION

The stability of unreinforced slopes is generally controlled by the shear strength of the soil in the slope and the slope angle. Slopes of cohesionless materials are usually stable up to slope angles of 30° to 35°, while the maximum stable slope for compacted cohesive soils is typically 26°. If designs require steeper slopes, then reinforcement is needed.

This paper describes a simple slope reinforcement design procedure, in which multiple layers of geosynthetic reinforcement are used to increase the stability of potentially unstable new construction or for the reparation of failed slopes.

Characteristics of the Procedure

- No complex iteration required
- Circular failure surfaces with a choice of design safety factor
- Pore pressures and surcharges considered
- Variable soil types
- Choice of lift thicknesses
- Design for pullout included

Scope

The procedure is based on the following construction practices and observed performance:

- Reinforced slopes consist of relatively homogeneous soils since they are usually remolded and compacted;
- Variable lift thicknesses are generally impractical;
- When geosynthetically reinforced slopes fail, they mainly do so in their lower third (3); and
- Site location and project budgets often affect the reinforcement selection as much as the slope geometry and soil conditions at the site.

It is assumed that the foundation of the slope has adequate sliding resistance and is stable with respect to bearing capacity.

The design of geosynthetic reinforcement involves determining: 1) additional tensile force required for overall stability, 2) geosynthetic tensile strength required by each layer, and 3) reinforcement length required to resist pullout.

DESIGN PROCEDURE

Unreinforced Slope Stability

The procedure is based on moment equilibrium, not force equilibrium; thus it is only applicable to circular failure surfaces. The first step of the procedure is to determine the critical slip circle of the unreinforced slope. The following information is needed: 1) centroid, 2) factor of safety, and 3) resisting moment of the critical sliding mass. The first two items can be easily obtained from common slope stability analyses, and the last item can be obtained using graphical methods.

Surcharges and pore pressures within the slope environment can also be considered, provided the procedure used for the analysis of the unreinforced slope has these capabilities. The resisting moment also needs to reflect any additional surcharge and pore pressures.

Additional Tensile Force Required for Stability

With geometric and soil characteristics of the failure surface known, the additional tensile force (ΣT) needed for stability can be calculated from:

$$FS_{wg} = \frac{M_R + R\Sigma T}{M_D} \quad \text{and} \quad FS_{wog} = \frac{M_R}{M_D}$$

So

$$\Sigma T = \frac{FS' M_R}{FS_{wog} R} \quad (1)$$

where FS_{wog} = factor of safety without geosynthetic reinforcement,
 FS' = increase in factor of safety desired ($FS_{wg} - FS_{wog}$),
 FS_{wg} = factor of safety with geosynthetic reinforcement,
 M_R = resisting moment of unreinforced mass, and
 R = radius of critical failure circle.

Equation 1 is based on conventional limiting equilibrium principles, and a detailed derivation is given in (12). This equation neglects any resistance the geosynthetic may provide normal to the slip surface. As shown in Fig. 1, the increase in normal force along the slip surface produced by the geosynthetic is $T \sin \alpha$ while the tangential force is $T \cos \alpha$, where T is the geosynthetic tensile force.

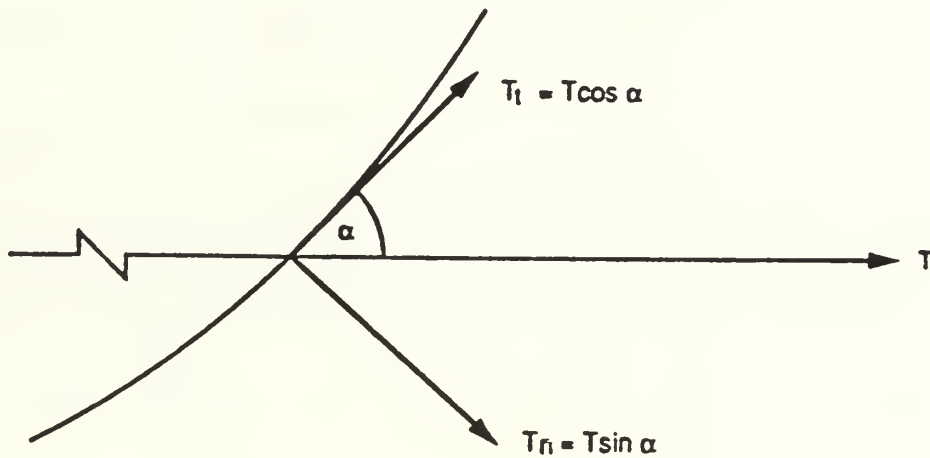

Figure 1. Components of Reinforcing Force

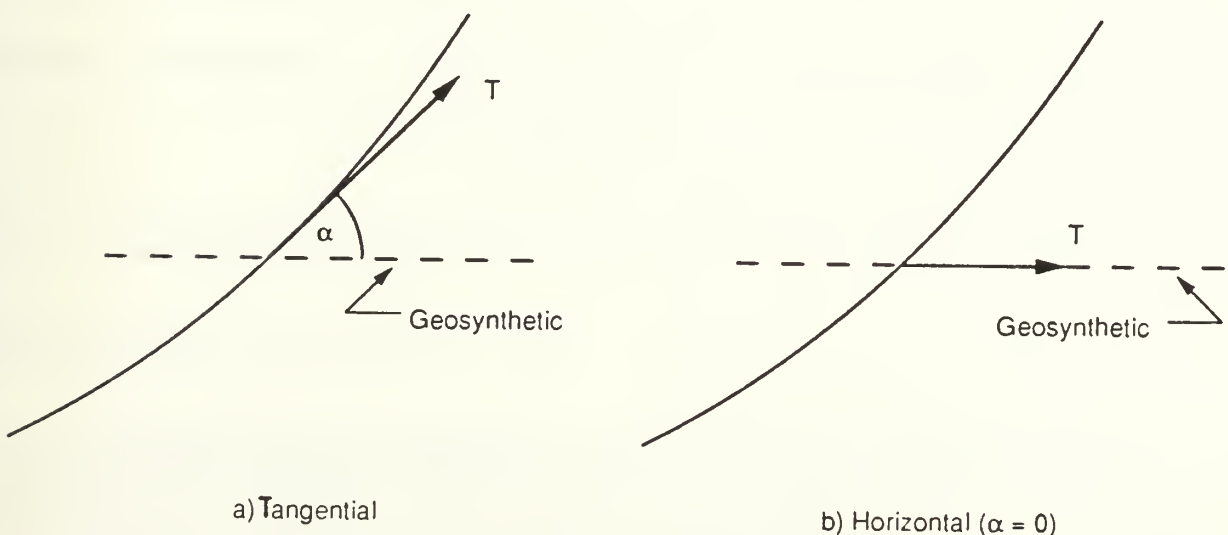

Figure 2. Reinforcing Force Orientation

To evaluate the effect of a possible increase in normal stress on the potential slip surface, two extremes of geosynthetic force orientation are shown in Fig. 2; they range from tangential to the slip surface ($\alpha > 0$) to horizontal ($\alpha = 0$). The assumption of a tangential geosynthetic force produces the lowest tensile forces required for stability, while assuming the geosynthetic force to be horizontal will produce the highest force. For example, Humphrey (5) assumed that the geosynthetic provides only a resisting moment or force and does not increase the normal stresses on the slip surface. On the other hand, Jewell (6), Murray (9), Schneider and Holtz (11), and Schmertmann, et al. (10) considered the increase in normal stress on this surface. In fact, Schmertmann, et al. (10) arbitrarily assumed that the geosynthetic force is inclined at 0.25α . Bonaparte and Christopher (2) concluded that "the orientation of the reinforcement at failure will depend on a number of factors including the load-deformation characteristics of the reinforcement, its flexural rigidity, and the stress-strain characteristics of the embankment-foundation system." Accurately determining these factors is beyond the scope of this paper. Because no information exists as to the actual inclination in the field, we have assumed the geosynthetic force to be horizontal and acting in the plane of the geosynthetic. This assumption produces the most conservative value of the force.

To account for the increase in normal stress produced by the geosynthetic, the total tensile force in Eq. 1 was modified as follows:

When α is 45° or greater, it is assumed that the normal force equals the tangential force. This assumption becomes more conservative as α increases, because $\sin \alpha > \cos \alpha$ for $\alpha > 45^\circ$. Two other ranges for α [$\alpha < 25^\circ$ and $25^\circ < \alpha < 45^\circ$] and their corresponding total tensile force modifications are similarly defined below. These ranges are arbitrary but conservative. Equation 2 gives these modifications to the total tensile force.

$$\text{For } \alpha \geq 45^\circ: \Sigma T' = \frac{\Sigma T}{1 + \tan \phi} \quad (2a)$$

$$\text{For } 25^\circ < \alpha < 45^\circ: \Sigma T' = \frac{\Sigma T}{1 + 0.5 \tan \phi} \quad (2b)$$

$$\text{For } \alpha < 25^\circ: \Sigma T' = \frac{\Sigma T}{1 + 0.35 \tan \phi} \quad (2c)$$

The actual α value depends on the location of the critical surface and slope geometry or:

$$\alpha = \cos^{-1} \left(\frac{Y_0 - H/3}{R} \right)$$

where Y_0 = the vertical distance between the centroid of the critical slip surface and the bottom of the slope (y_{ob} in Fig 3).

Geosynthetic Tensile Strength Required Per Layer

With the knowledge of the additional tensile force needed for stability, the individual geosynthetic strengths can now be determined. In order to give maximum flexibility, three different reinforcing options are available. The first allocates the same geosynthetic spacing and strength throughout the slope. Option No. 2 enables the designer to control both the geosynthetic spacing as well as the strength in the upper and lower halves of the slope. In the third option the geosynthetic spacing is constant throughout, but the designer can select different strength geosynthetics in the top and bottom portions of the slope.

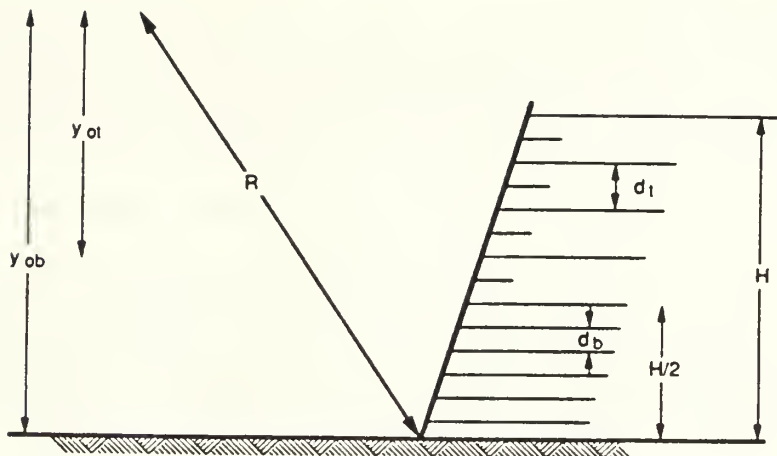

Figure 3. Reinforcement Definitions

The geosynthetic strengths required in the upper layers (T_u) and in the lower layers (T_l) of the slope are determined by Eqs. 3 and 4, respectively. Each equation is modified accordingly for the three options.

$$T_u = \frac{(1 - \text{Percent})(\Sigma T')(R)}{nfl_t(y_{ot}) - d_t[\Sigma(nfl_t)]} \quad (3)$$

$$T_l = \frac{(\text{Percent})(\Sigma T')(R)}{nfl_b(y_{ob}) - d_b[\Sigma(nfl_b)]} \quad (4)$$

where Percent = percent of force desired in lower portion of slope;

$$y_{ot} = Y_0 - H/2$$

$$y_{ob} = Y_0$$

R = radius of critical circle

$\Sigma T'$ = total tensile force required for stability

nfl = number of fabric layers (t=top, b=bottom)

d = spacing between layers (t=top, b=bottom)

A detailed derivation of Eqs. 3 and 4 can be found in (12)

Option One - Same Spacing and Strengths: - If the designer finds that only one geosynthetic type and spacing will be the most practical, Eq. 4 is used with the following modifications:

$$\text{Percent} = 100\% \text{ and } nfl_b = n_b - 1$$

where T_l in Eq. 4 is the geosynthetic strength for all the layers, and $n_b = H/d_b$ (rounding up to next whole number).

Option Two - Different Spacings and Strengths: - If the slope is higher than 10 to 15 m, it usually is feasible to consider two different strength geosynthetics and spacings. Because studies indicate that geosynthetically reinforced slopes fail mostly in the lower third of the slope (3), it seems prudent to increase the amount of reinforcement in the lower portion of the slope.

Fig. 3 illustrates the assumed reinforcement configuration for Option Two.

There are two different lift thicknesses, one in the top half of the slope (d_t) and one in the bottom half (d_b). From a construction standpoint this is more practical than varying the geosynthetic spacing continuously throughout the embankment. It is evident that the number of geosynthetic layers in the bottom nfl_b equals the number of lifts in the bottom (n_b), while the number of geosynthetic layers in the top (nfl_t) equals one minus the number of lifts in the top (n_t). Key relations include:

$$d_t/d_b = n_t/n_b = X$$

$$n_t = \frac{H}{2(X)d_b}$$

$$nfl_b = n_b; nfl_t = n_t - 1$$

where X is the ratio of the number of top layers to bottom layers.

The percent of total reinforcement force in the bottom half should range from 60% to 80%. With more than this amount, the top half may become unstable. Since cost is roughly proportional to tensile strength, it is generally cost effective to have more, lower tensile strength geosynthetic layers in the bottom, and fewer, higher tensile strength geosynthetic layers in the top. Sometimes geosynthetic selection may be limited by availability or construction costs to only one type and therefore one strength geosynthetic. For this situation, the percentage of reinforcement in the bottom giving similar T_u and T_l values (Eqs. 3 and 4) should be used. The higher of the two strengths (T_u or T_l) should be used for both.

Option Three - Same Spacings, Different Strengths: If the same geosynthetic spacing in both the upper and lower halves of the slope but with different strengths is desired, the same procedure as above is used with the following modifications:

$$d_t = d_b, n_t = H/(2d_b), \text{ and } n_b = n_t$$

Then Eqs. 3 and 4 are used as before.

Often the calculated number of geosynthetic layers (nfl_t and nfl_b) is not an integer. Then the required strength per layer is determined using these fractional values in Eqs. 3 and 4. The number of geosynthetic layers in the bottom is rounded up to the next whole number. After the geosynthetic strengths and their respective spacings are determined, the reinforcement locations can now be finalized from the foundation up, as shown in Fig. 3. The thickness of soil at the very top of the slope might be less than d_t in some cases, which is satisfactory unless it produces construction problems. Depending on d_t , short geosynthetic strips 1 to 2 m long may be needed midway in the upper lifts to help in compaction of the slope edges (see Fig. 3). The strength of these strips does not contribute to stability.

Geosynthetic Spacing Guidelines

In designing slope reinforcement, it is usually best that the reinforcement spacing be specified to be at some convenient multiple of typical compaction lift thicknesses, say 150 mm to 300 mm, which are appropriate for the backfill soil under consideration. When weaker geosynthetics are used, smaller lift thicknesses may be selected; with stronger reinforcement, thicker spacings are generally more economical, although they may require temporary support of the facing during construction. Even with temporary supports, thicker lifts may be more economical overall because of reduced construction time. The most economical designs should, of course, consider construction as well as material costs.

LENGTH OF GEOSYNTHETIC REINFORCEMENT

The length of geosynthetic in the upper and lower portions of the slope is controlled by two different conditions. The upper geosynthetic layers have to be sufficiently embedded into the slope to ensure that sufficient resistance is mobilized to develop the required individual geosynthetic forces. This is critical in the upper part of the slope, because the confining stress is less due to lower overburden stress. On the other hand, the geosynthetic layers in the bottom of the slope have to be long enough so that they produce enough resistance to prevent sliding. Schmertmann, et al. (10) use a similar concept.

Mobilized Resistance

The procedure for determining geosynthetic lengths in the upper half of the slope considers the length of geosynthetic required to mobilize the needed individual geosynthetic strengths. The traditional model (Fig. 4a) used for pullout length selection assumes that the mobilized resistance is uniform and equal to $2\tau_{\max}$ along the geosynthetic (4). This model requires either the same initial uniform displacement at every point on the geosynthetic or large geosynthetic movements at all points on the geosynthetic (approaching ultimate resistance). Because the geosynthetic is extensible and confined, the magnitude of local movements at different points along the geosynthetic will probably never be the same. Therefore, mobilized resistance will also never be the same, but will decrease with distance from the critical slip surface.

Beech (1) developed a procedure for predicting the pullout tension (which is a function of the resistance) as a function of the geosynthetic displacement. Fig. 4b shows the model we used, which is a generalization of the curves in Beech (1). It considers the mobilized shear strength to attenuate linearly from a maximum at the critical surface to zero at the end of the geosynthetic. Equation 5 is derived by setting the area under the curve equal to the required individual geosynthetic strengths (T); or

$$L_e = \frac{T}{\tau_{\max}} \cdot FS \quad (5)$$

where L_e = length of geosynthetic extending beyond assumed failure surface

$$\tau_{\max} = \text{maximum mobilized shear strength} = \sigma_n \tan \phi_{SG}$$

$$\sigma_n = \text{overburden stress at the elevation of the geosynthetic,}$$

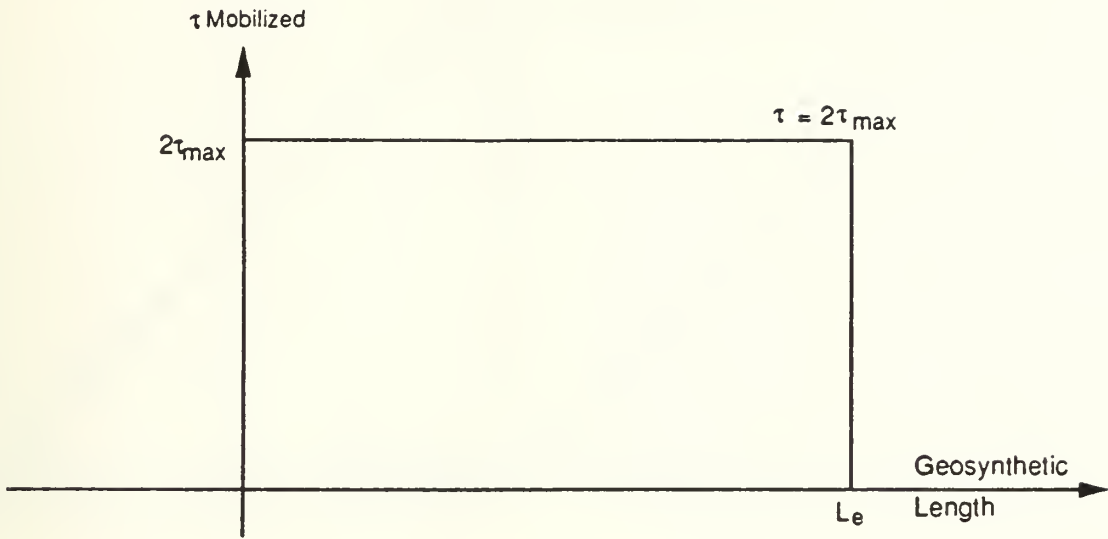

a) Traditional Model

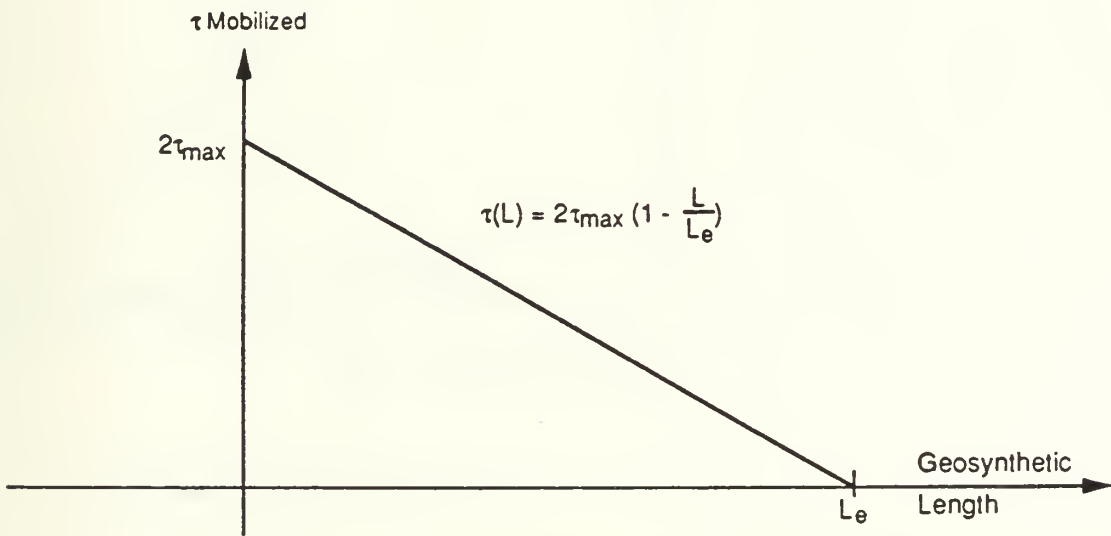

b) Proposed Model

Figure 4. Mobilized Resistance Models

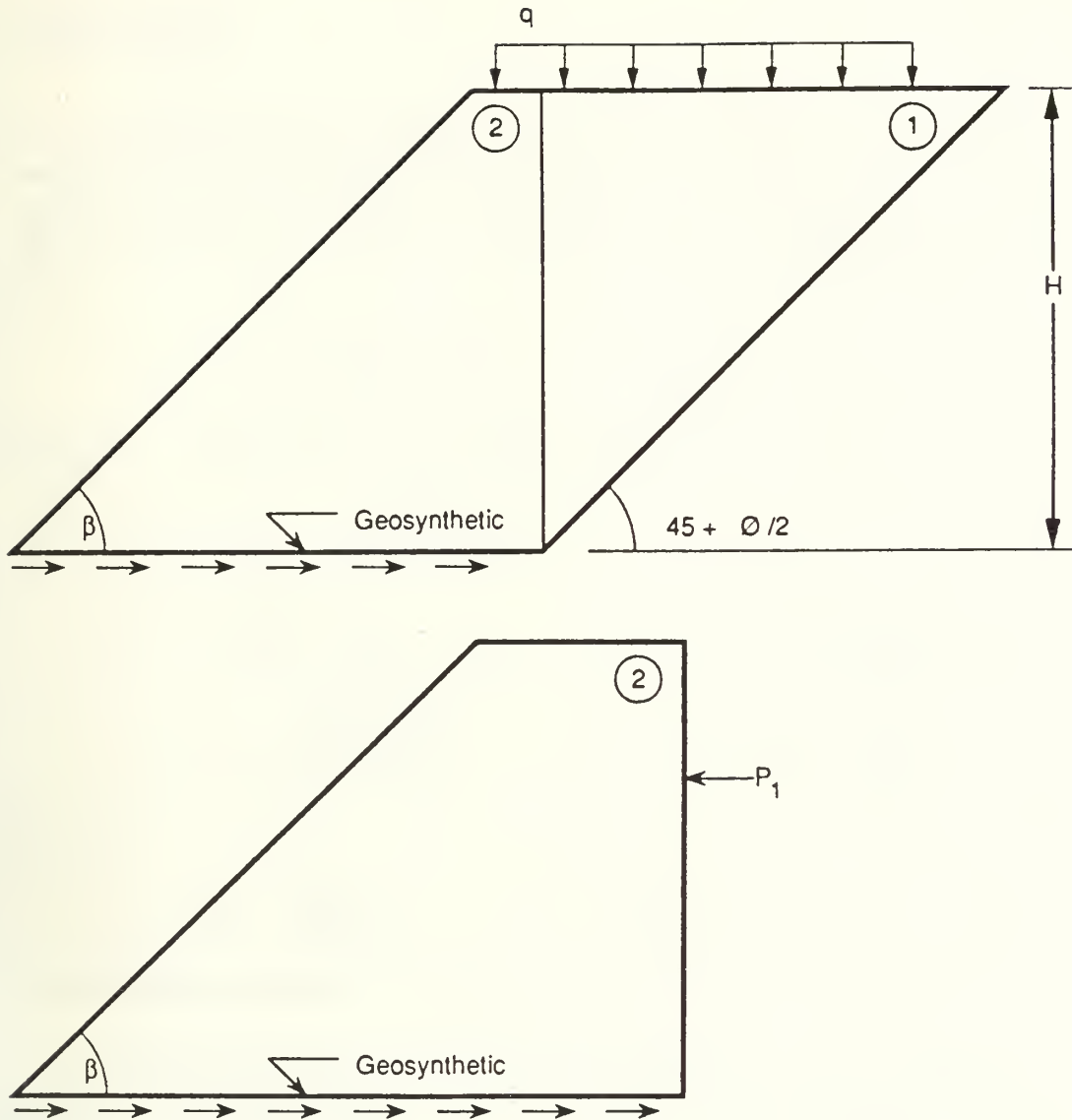

Figure 5. Sliding Block Model

ϕ_{SG} = soil-geosynthetic friction angle.

The factor of safety (FS) against pullout is required because of uncertainty in the maximum mobilized shear strength. Selection of the safety factor, therefore, depends on the designer's confidence in the value of this strength and how critical the slope is with respect to a potential failure. The soil-geosynthetic friction ϕ_{SG} is influenced by both the soil and geosynthetic, and it can be estimated from the literature (7;8). A geosynthetic with openings similar to the soil particle sizes will have higher soil-geosynthetic friction values, while geosynthetics which do not interlock well will obviously have lower friction.

Sliding Resistance

The geosynthetic layers lower in the slope should be analyzed for possible sliding. As seen in Fig. 5, the model used for this analysis divides the slope into two blocks. The first block is an active wedge, which pushes against the second wedge with a force P_1 . This force is assumed to act horizontally. The second wedge offers resistance in the form of friction at the soil-geosynthetic interface. By balancing the capacity and demand, geosynthetic length determination is computed by Eqs. 6:

$$P_1 = \frac{wt + \text{surch} - coh}{1 + \tan\phi \tan(45^\circ + \phi/2)}$$

where $wt = [\frac{1}{2}H^2\gamma \tan(45^\circ - \phi/2)][\tan(45^\circ + \phi/2) - \tan\phi]$

$$\text{surch} = q\left[H - \frac{H \tan\phi}{\tan(45^\circ + \phi/2)}\right]$$

$$coh = \frac{cL_1}{\cos(45^\circ + \phi/2)}$$

$$L_1 = \frac{H}{\sin(45^\circ + \phi/2)}$$

$$L = \sqrt{\frac{2P_1FS}{\gamma \tan\beta \tan\phi_{SG}}}$$

$$L_T = \frac{H}{\tan\beta} \quad (6a)$$

If $L > L_T$:

$$L = \frac{P_1FS}{H\gamma \tan\phi_{SG}} + \frac{L_T}{2} \quad (6b)$$

where the symbols are defined in Fig. 5.

The safety factor for pullout is based on the uncertainty of the resistance developed at the soil-geosynthetic interface as well as the driving force. Again, selection of the factor of safety depends on the designer's confidence in the soil-geosynthetic interface behavior and how critical the slope is.

Geosynthetic Lengths - Intermediate Layers

The lengths of intermediate geosynthetic layers are linearly interpolated between the length of the bottommost layer (designed against sliding) and the length of the top layer (designed against pullout).

CONCLUDING REMARKS

The design procedure presented herein can easily be programmed for use on microcomputers and a copy is available from the authors.

EXAMPLE PROBLEM

- o A slope stability program identified the critical failure surface:

$$(X_0, Y_0) = (-46.1, 95.1) \quad R = 105.7 \text{ ft} \quad FS = 0.73.$$

- o The resisting moment was found to be 2,534,400 lb-ft.

- o Equation 1 gives the Total Tensile Force required for stability (FS=1.5):

$$\begin{aligned} \Sigma T &= \frac{(1.5 - 0.73)(2534400 \text{ lb-ft})}{(0.73)(105.7 \text{ ft})} \\ &= 25,290 \text{ lb/ft-width} \end{aligned}$$

- o Equation 2b gives the modified Total Tensile Force:

$$\begin{aligned} \Sigma T' &= \frac{(25,290 \text{ lb/ft})}{(1 + 0.5 \tan 34^\circ)} \\ &= 18910 \text{ lb/ft} \end{aligned}$$

- o Option 1 is used to find Tensile Strength required per layer. The lift thickness will be 3.0 feet (d_0):

$$n_{d_0} = 40 \text{ ft} / 3 \text{ ft} = 14 \quad n_{f_0} = 14 - 1 = 13 \quad \text{Percent} = 1.0$$

- o Equation 4 gives the Tensile Strength required per layer:

$$\begin{aligned} T_1 &= \frac{(1.0)(18910 \text{ lb/ft})(105.7 \text{ ft})}{13(95.1 \text{ ft}) - 3 \text{ ft}(91)} \\ &= 1671 \text{ lb/in} \end{aligned}$$

- o Equation 5 gives the Length of the upper geosynthetic layer (FS=1.5):

$$\begin{aligned} L_u &= \frac{1671 \text{ lb/in}}{162 \text{ psf}} (1.5) \\ &= 18 \text{ ft} \\ L &= L_u + L \\ &= 18 \text{ ft} + 5 \text{ ft} \\ &= 23 \text{ ft} \end{aligned}$$

- o Equation 6 gives the Length of the lower geosynthetic layer (FS=1.5):

$$L = \frac{(334451 \text{ lb/ft})(1.5)}{37 \text{ ft}(127.4 \text{ pcft}) \tan 23^\circ} + \frac{37 \text{ ft}}{2} = 43.5 \text{ ft}$$

- o Taper the lengths of the intermediate layers:

Layer	Height From Bottom (ft)	L (ft)
1	3.00	44.5
2	6.00	43.0
3	9.00	41.0
4	12.00	39.0
5	15.00	37.5
6	18.00	35.5
7	21.00	34.0
8	24.00	32.0
9	27.00	30.0
10	30.00	28.5
11	33.00	26.5
12	36.00	25.0
13	39.00	23.0

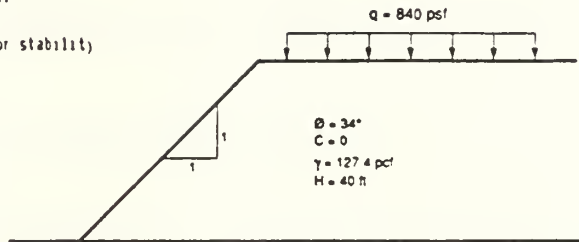

Example Problem

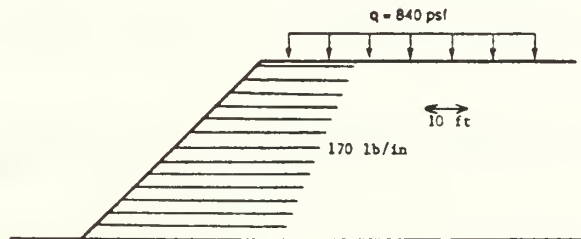

Example Problem

REFERENCES

- (1) Beech, J. F., "Importance of Stress-Strain Relationships in Reinforced Soil System Design," Proceedings of Geosynthetics '87, New Orleans, 1987, Vol. 1, pp. 133-144.
- (2) Bonaparte, R., and Christopher, B. R., "Design and Construction of Reinforced Embankments over Weak Foundations," Transportation Research Record 1153, pp. 26-39.
- (3) Christopher, B. R., Personal Communication, 1987.
- (4) Christopher, B. R., and Holtz, R. D., Geotextile Engineering Manual, FHWA, Washington D.C., 1985, 1044 pp.
- (5) Humphrey, D. N., "Design of Reinforced Embankments," Joint Highway Research Project, Purdue University, Report No. JHRP-86-16, 1986.
- (6) Jewell, R. A., "A Computer Design Method for Equilibrium Soil Structures Using Limit Equilibrium Analysis," Report prepared by Binnie and Partners, London, for Netlon, Ltd., 1981, 6 pp.
- (7) Koerner, R. M., Designing with Geosynthetics, Prentice-Hall, Englewood Cliffs, NJ, 1986, 424 pp.
- (8) Martin, J. P., Koerner, R. M., and Whitty, J. E., "Experimental Friction Evaluation of Slippage between Geomembranes, Geotextiles and Soils," Proceedings of the International Conference on Geomembranes, Denver, 1984, Vol. 1, pp. 191-196.
- (9) Murray, R. T., "Fabric Reinforcement of Embankments and Cuttings," Second International Conference on Geotextiles, Las Vegas, 1982, Vol. III, pp. 707-713.
- (10) Schmertmann, G. R., Chouery-Curtis, V. E., Johnson, D. D., and Bonaparte, R., "Design Charts for Geogrid-Reinforced Soil Slopes," Proceedings of Geosynthetics '87, New Orleans, 1987, pp. 108-120.
- (11) Scheider, H. R., and Holtz, R. D., "Design of Slopes Reinforced with Geotextiles and Geogrids," Geotextiles and Geomembranes, No. 3, 1986, pp. 29-51.
- (12) Verduin, J. R., "Geosynthetically Reinforced Slopes: A Design Procedure," Report for CE 6970 - Geotextiles and Geomembranes, Purdue University, 1987, 14 pp. + Appendices (available from the authors).

1. Log-spiral and linear wedge
2. Yes
3. Inclined at an angle, β , to horizontal
4. a. Developed for geotextiles
b. ϕ only
5. Factor ultimate tensile strength of reinforcement and use as allowable strength. Factor of safety applied to composite structure.
6. Assumes equal spacing of geotextiles and wrapped slope face.

From Lesnchinsky and Perry, 1987

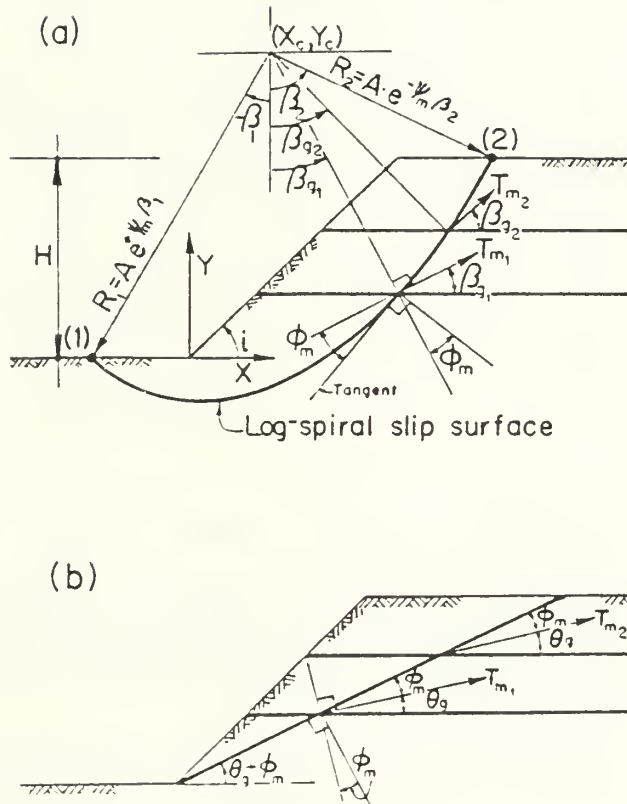

Figure 2. Failure Mechanisms:
 (a) Rotational, and (b) Translational.

From Leshchinsky and Perry, 1987

embedment length of the geotextile at the bottom -- see Fig. 3. The condition in eq. (4c) (i.e., $l_{e1} < l_e$) can exist only when $\phi_F > \phi$.

The restraining force t_j counterbalances a force generated within the sliding mass. To ensure that t_j can indeed develop within the active mass as well as to retain the soil at the wall face, each geotextile sheet is folded back at the wall face and re-embedded over a length $(l_a)_j$ --see Fig. 3. To determine $(l_a)_j$, the following assumptions are combined with the rationale used in stating eq. (2):

1. The average elevation of l_a is at the center in between two adjacent geotextile sheets.
2. The full intensity of t_j is carried along $(l_a)_j$.
3. For non-vertical walls the average overburden pressure acting along l_a is proportional to $(ml_a+d)/2$ so long as $m(l_a/2)+d$ is less than H . One can see the geometrical interpretation of this assumption by looking at Fig. 3.

Based on the above, the following approximate expressions are assembled

$$l_a = \begin{cases} (d/2m) \left\{ \sqrt{1 + 8mHl_e/d^2} - 1 \right\} & \text{only for } m < \infty \text{ and } (ml_a/2) \leq (H-d) \\ 2l_e & \text{for all cases} \\ \geq 3 \text{ ft.} & \text{for all cases} \end{cases} \quad (6)$$

For each problem, the longest l_a should be selected. Notice that a minimal value of $l_a=3$ ft., adopted from Steward et al. (12), should ease construction and, physically, will ensure adequate embedment. It is interesting to note that, in most practical cases, eq. (6) will indicate that l_a is specified by its required minimal value.

Figures 6a and 6b are design charts. They represent the results only for the critical mode of collapse, i.e., either planar or log-spiral failure surface.

It is recommended to use a factor of safety of $F_s=1.5$ for the composite structure. This F_s value is typical in design of slopes where long-term stability is concerned. The following are the steps necessary to utilize the charts in the design process:

1. Determine the wall's geometry; i.e., height H and face average inclination -- 1 (horizontal): m (vertical).
2. Determine the retained soil properties; i.e., unit weight γ and friction angle ϕ .
3. Select a value for the composite structure factor of safety F_s .
4. Select the geotextile sheets spacing, d . To ease construction, this spacing should be limited to a maximum of $d=12$ inches.
5. Compute $\phi_m = \tan^{-1}[(\tan\phi)/F_s]$.
6. For the given m and computed ϕ_m , determine T_{m1} utilizing Fig. 6a.
7. The number of the required equally spaced geotextile sheets is $n=H/d$.
8. Compute the required tensile resistance of the geotextile sheet at the toe elevation $t_1 = T_{m1} F_s \gamma H^2/n$.
9. Calculate the required tensile resistance of all other geotextile sheets using eq. (1); i.e., $t_j = t_1(H-y_j)/H$.
10. Based on the recommendations in the last section and the required t_j , select the proper geotextiles. In case the specified geotextile tensile strength is exces-

From Leshchinsky and Perry, 1987

sively high as compared to available geotextiles, decrease the spacing d and return to step 7. If only one type of geotextile is used, skip step 9; t_1 will be used to determine this geotextile type.

11. Use eq. (4) to compute the required length of the restraining zone so that the geotextiles' tensile resistance can actually develop; i.e., calculate l_e and l_{e1} .
12. Compute $\lambda_{T\phi} = (nt_1) / (\gamma H^2 \tan\phi)$.
13. Based on m and $\lambda_{T\phi}$, determine L from Fig. 6b.
14. Compute $l = L \cdot H$ where l defines the location at which the potential slip surface intersects the crest.
15. Based on eq. (6) select the geotextile re-embedment length l_a at the wall face - see Fig. 3.
16. Determine the required length of each geotextile sheet j : $l_e + l + d + l_a + (H - y_j) / m$. For geotextile $j=1$ use l_{e1} rather than l_e . Add one foot as tolerance permitting curvature along l_a and over the wall face.

Equal application of F_s to two different materials (i.e., to $\tan\phi$ and t_j) appears rather arbitrary although such an approach is common in similar problems (e.g., conventional stability analysis of layered slopes). In retrospect, however, one can come up with a justification for this F_s application as far as the geotextile reinforced problem is concerned. Combining eqns. (1) and (4) (or steps 9 and 11 above) yields $t_j = 2\gamma(H - y_j)l_e \tan(0.67\phi)$; i.e., t_j is controlled and, in fact, is equal to the pullout resistance. Thus applying F_s to t_j or to $\tan(0.67\phi)$ is equivalent. Consequently, F_s is actually related only to the retained soil friction making the concept of equal mobilization reasonable.

Geotextile Tensile Resistance

As was stated before, the internal stability can be viewed from another prospective. One can assume that the soil is fully mobilized (i.e., $\phi_m = \phi$) and that the margin of safety then is solely contributed by the geotextile tensile resistance. This margin of safety is defined as

$$F_g = t_j / t_{mj} \quad (7)$$

where F_g is the factor of safety with respect to geotextile tensile resistance; $t_{mj} = T_{mj} \gamma H^2 / n$ = the tensile resistance of geotextile j yielding a composite structure which is at the verge of failure (i.e., $F_s = 1.0$); and t_j is the required tensile resistance of geotextile j so that F_g is attained. It is recommended to use $F_g = 2.0$. It can be verified that this F_g value combined with the suggested design procedure will render structures possessing safety factors greater than one when their stability is analyzed using the design methods introduced by Steward et al. (12) and Murray (19).

To design a wall possessing a specified F_g value, the design charts (Figs. 6a, 6b) are utilized. The composite factor of safety, however, must be taken as $F_s = 1.0$ when using these charts. The following are the steps necessary to utilize the charts, assuming that a preliminary design, based on F_s , has been carried out:

1. Select a value for F_g .
2. Take $F_s = 1.0$; hence, $\phi_m = \phi$.
3. Use Fig. 6a to determine T_{m1} for m and ϕ_m .
4. Compute the required tensile resistance of the geotextile sheet at the toe elevation $t_1 = F_g T_{m1} \gamma H^2 / n$.
5. Calculate the required tensile resistance of all other geotextile sheets using eq. (1); i.e., $t_j = t_1 (H - y_j) / H$.
6. Compare t_j for all n sheets with those obtained based on a prescribed F_s in the previous section. If t_j here is smaller, take the previous t_j for

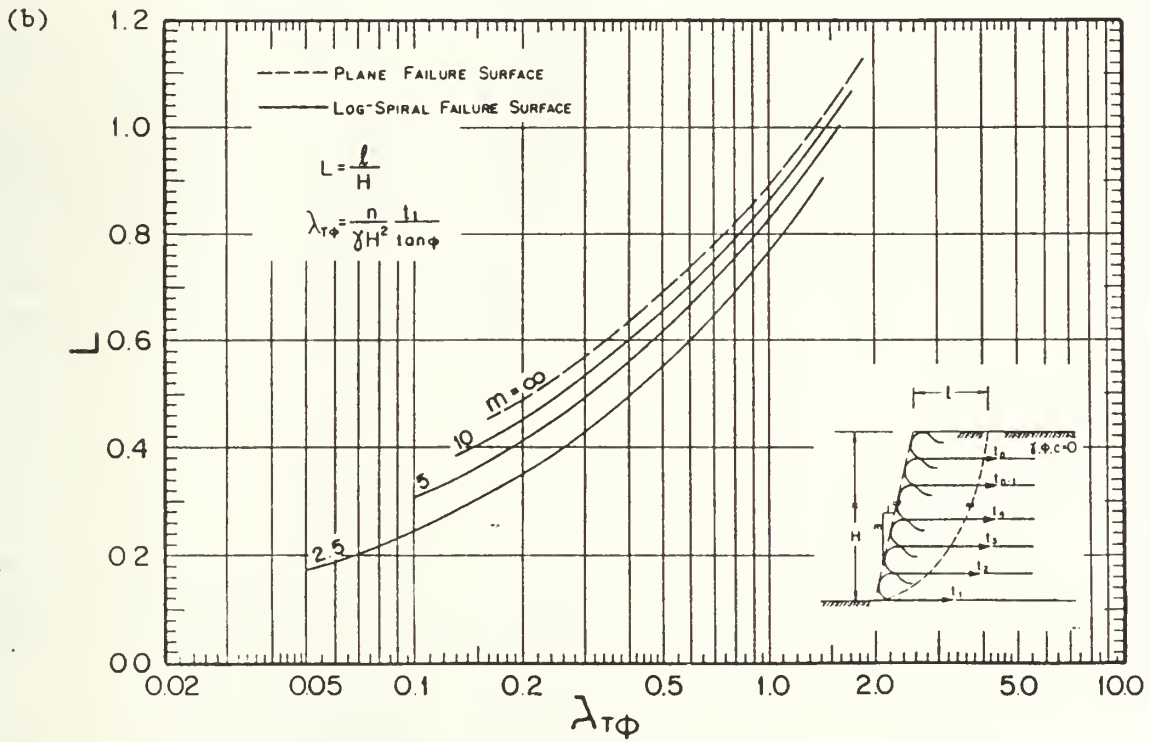
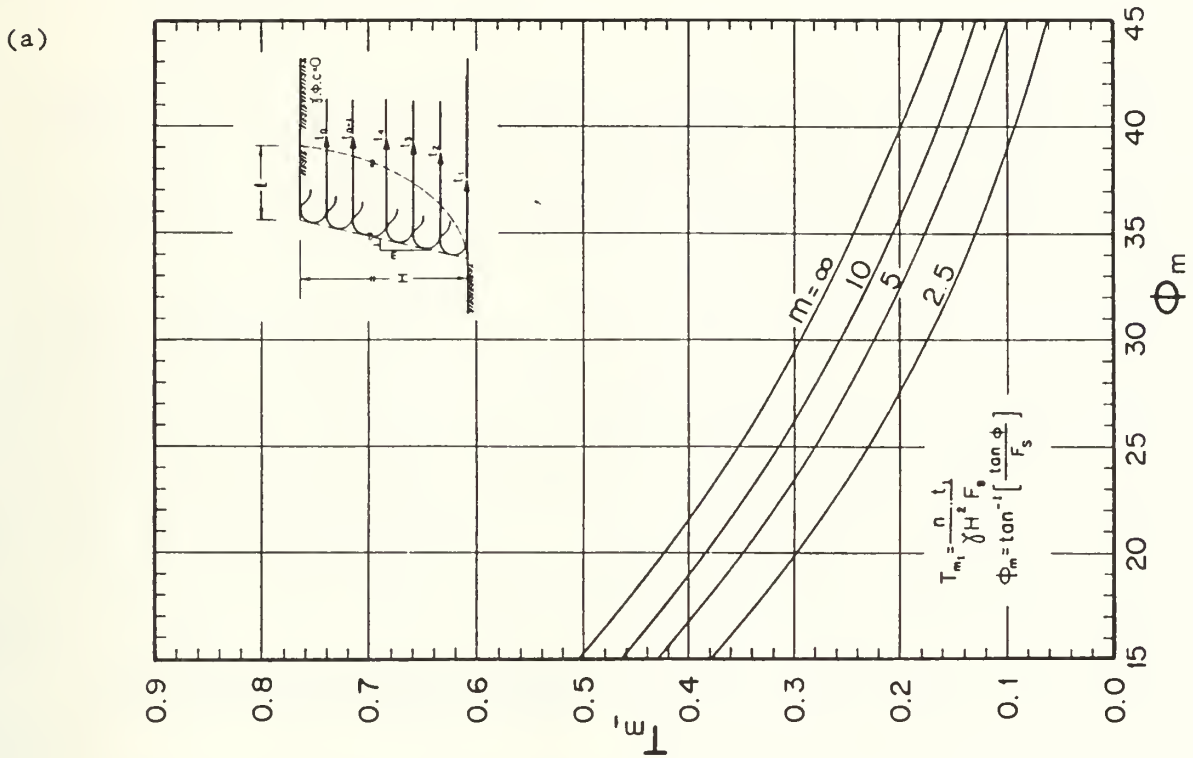

Figure 6. Design Chart.

From Leshchinsky and Perry, 1987

- design and skip to the next step. If it is larger than the previously required, select the proper geotextiles based on the recommendations in the last section. In case the specified geotextile tensile strength is excessively high, increase the number of geotextile sheets n and return to step 4.
7. Regardless of the conclusion in step 6, in steps 7 and 8 use t_1 as computed in step 4. Use eq. (4) to compute the required length of the restraining zone l_e and l_{e1} .
 8. Compute $\lambda_{T\phi} = (nt_1) / (\bar{F}_g \gamma H^2 \tan \phi)$. Notice that t_1 / F_g is used here, whereas before only t_1 was used.
 9. Use Fig. 6b to determine L and m and $\lambda_{T\phi}$.
 10. Compute $l = L \cdot H$.
 11. Is $(l + l_e)$ smaller than the value obtained based on a prescribed F_s ? If yes, then the embedment length is dictated by the procedure based on the safety factor for the composite structure F_s . If no, proceed.
 12. Select l_a based on eq. (6).
 13. Determine the required length of each geotextile sheet j : $l_e + l + d + l_a + (H - y_j) / m$. Add one foot as tolerance. Use l_{e1} instead of l_e for geotextile #1.

Surcharge Load

Design charts, similar in nature to Fig. 6, which deal with uniform and strip surcharge loads are given elsewhere (11).

Example

Given a wall data: height $H=10$ ft. and face inclination $1:\infty$ ($m=\infty$, i.e., vertical wall). The retained soil data: total unit weight $\gamma=120$ lb/ft³ and friction angle $\phi=35^\circ$. The foundation possesses $\phi_F=20^\circ$.

Design based on $F_s = 1.5$: Following the presented procedure one can choose a spacing of $d=1$ ft. Computing ϕ_m gives $\phi_m = \tan^{-1}[(\tan 35^\circ) / 1.5] = 25^\circ$. For $m=\infty$ and $\phi_m=25^\circ$, it follows from Fig. 6a that $T_{m1}=0.35$. For a spacing of $d=1$ ft., the number of required geotextile sheets is $n=H/d=10/1=10$ sheets. Hence, the required tensile resistance of the geotextile sheet at the toe elevation is $t_1 = T_{m1} F_s \gamma H^2 / n = 0.35 \cdot 1.5 \cdot 120 \cdot (10)^2 / 10 = 630$ lb. per foot width. Using the equation $t_j = t_1 (H - y_j) / H$, where y_j is zero at the toe and H at the crest, one can calculate the required tensile resistance of each geotextile sheet:

Geotextile # (j)	1	2	3	4	5	6	7	8	9	10
Elevation y_j [ft]	0	1	2	3	4	5	6	7	8	9
t_j [lb/ft]	630	567	504	441	378	315	252	189	126	63

Now, a geotextile can be selected based on the recommendations. If only one type of geotextile is to be used, t_1 should be the key value for selecting this type. If, however, geotextiles with decreasing strength properties are preferred, take the maximum t_j for each cluster of homogeneous geotextiles as the key value.

The required length of the restraining zone, so that t_j can realize without pullout, should be calculated based on eq. (4); i.e.,

$$l_e = 630 / [2 \cdot 120 \cdot 10 \cdot \tan(0.67 \cdot 35^\circ)] = 0.61 \text{ ft} \approx 8''$$

$$l_{e1} = 630 / \{120 \cdot 10 \cdot [\tan(0.67 \cdot 35^\circ) + \tan(0.67 \cdot 20^\circ)]\} = 0.78 \text{ ft} \approx 10''$$

For all practical purposes a uniform value of l_e equals one foot can be selected.

Thesis
S41861 Setser
c.1 Slope reinforcement
design using geotextiles
and geogrids.

Thesis
S41861 Setser
c.1 Slope reinforcement
design using geotextiles
and geogrids.



thes41861
Slope reinforcement design using geotext



3 2768 000 89352 3
DUDLEY KNOX LIBRARY